

- 1.1.01 B: Profile listing, Mullion/Transoms.
- 1.1.02 B: Profile listing, cappings.
- 1.1.03 D: Gaskets and accessories.
- 1.1.04 C: Accessories.
- 1.1.05 : Brackets.
- 1.1.06 : lxx of Mullions sleeved.
- 1.1.07 : Profile assembly.
- 1.1.08 B: Gapping options.
- 1.1.09 B: Glazing options - Mullions.
- 1.1.10 C: Glazing options - Transoms
- 1.1.11 : System applications.
- 1.1.12 B: Typical head details.
- 1.1.13 B: Typical head detail into kingspan panels.
- 1.1.14 C: Typical cill details
- 1.1.15 B: Typical mid span fixing.
- 1.1.16 B: Typical mid span fixing.
- 1.1.17 A: Typical sash insert - 24mm.
- 1.1.18 B: Concealed sash detail.
- 1.1.19 B: Typical sash insert - 28mm.
- 1.1.20 B: Typical door head detail.
- 1.1.21 B: Typical jamb detail.
- 1.1.22 B: Typical door jamb detail.
- 1.1.23 B: Corner details.
- 1.1.24 B: Sloped glazing - head detail.
- 1.1.25 B: Sloped glazing - eaves detail.
- 1.1.26 B: Sloped glazing - jamb detail.
- 1.1.27 B: False mullion detail.
- 1.1.28 B: Typical ridge detail.
- 1.1.29 B: Typical ridge detail.
- 1.1.30 B: Double transom ridge detail
- 1.1.31 C: Sloped glazing - cill detail
- 1.1.32 A: Typical details MU899-60 (60mm transom)
- 1.1.33 A: Insert details

AMS Ltd. Wallingstown, Little Island, Co. Cork:

Tel: 021 4705100 **Fax:** 021 4705198, **E-mail:** pohara@ams.ie, **Web:** www.ams.ie



MU 800 SERIES MULLION DRAINED SYSTEM

Mullions and transoms

Scale NTS

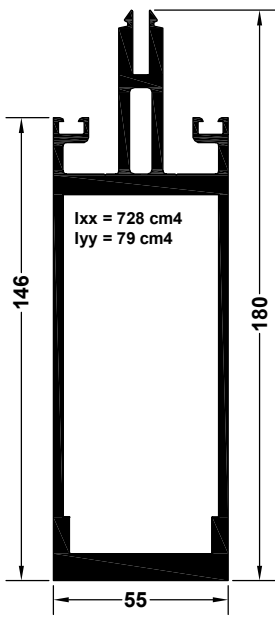

**MU 898
MULLION**

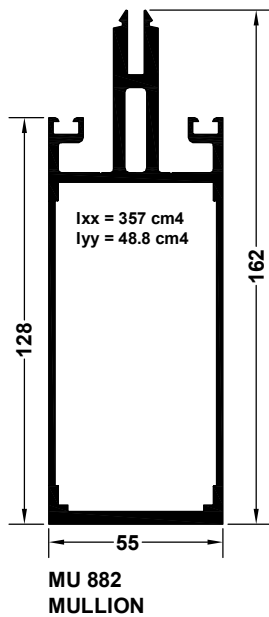

**MU 882
MULLION**

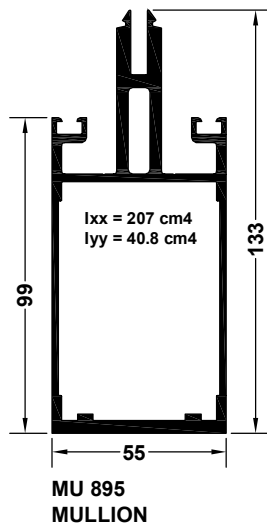

**MU 895
MULLION**

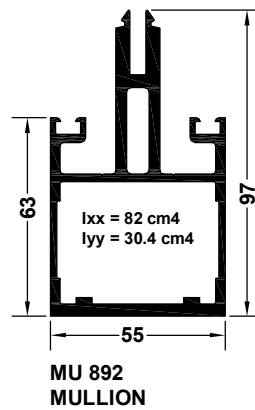

**MU 892
MULLION**

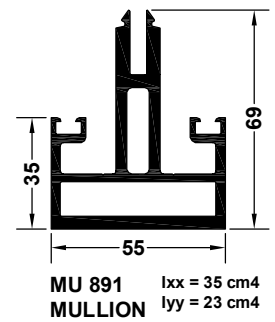

**MU 891
MULLION**

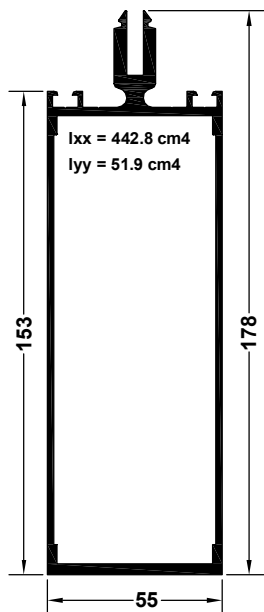

**MU 899
TRANSOM**

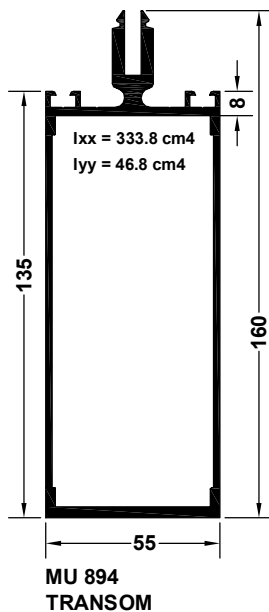

**MU 894
TRANSOM**

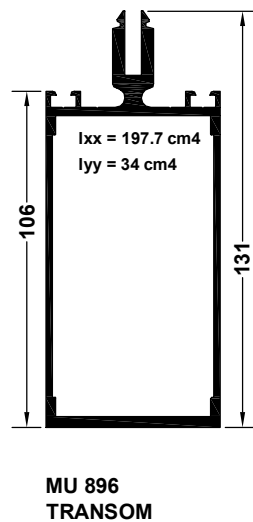

**MU 896
TRANSOM**

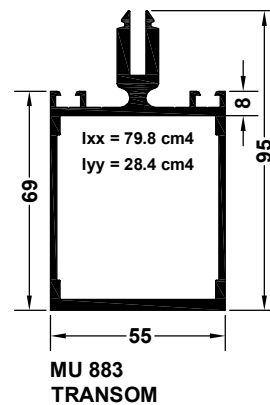

**MU 883
TRANSOM**

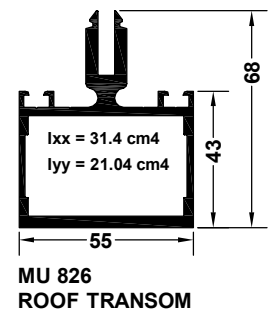

**MU 826
ROOF TRANSOM**

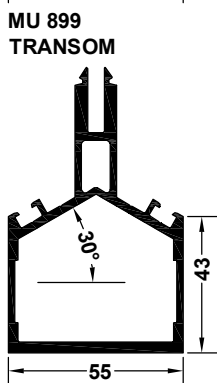

**MU 827
30° RIDGE BAR**

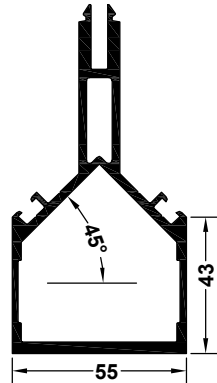

**MU 828
45° RIDGE BAR**

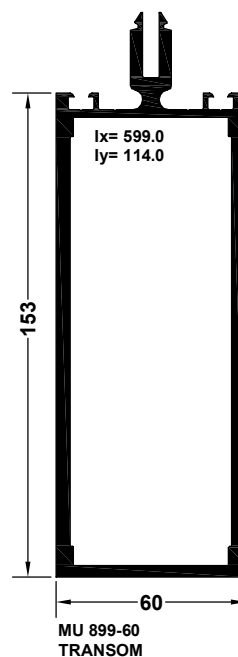

**MU 899-60
TRANSOM**

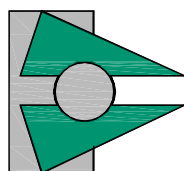

MU 800 SERIES MULLION DRAINED SYSTEM

Cappings and pressure plates

Scale 1:2

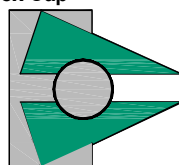
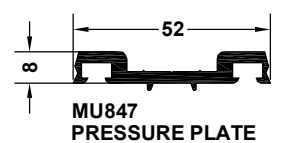
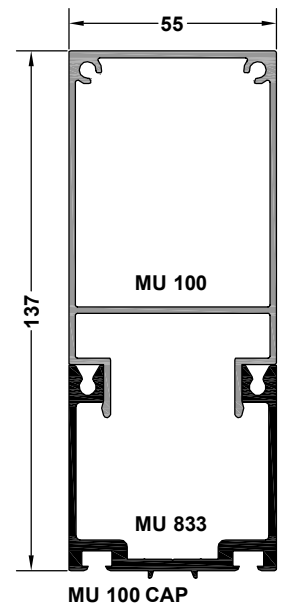
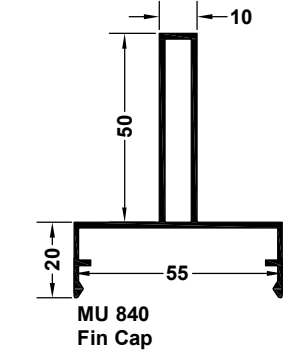
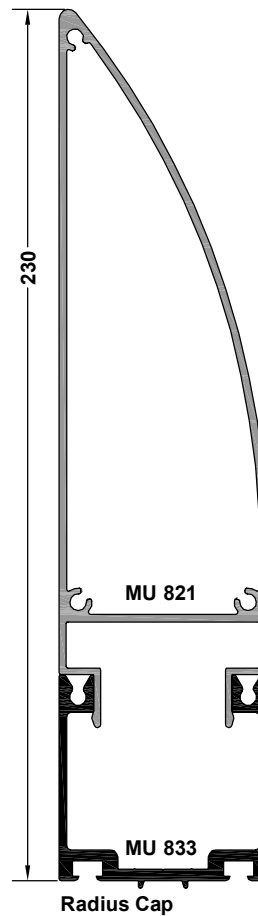
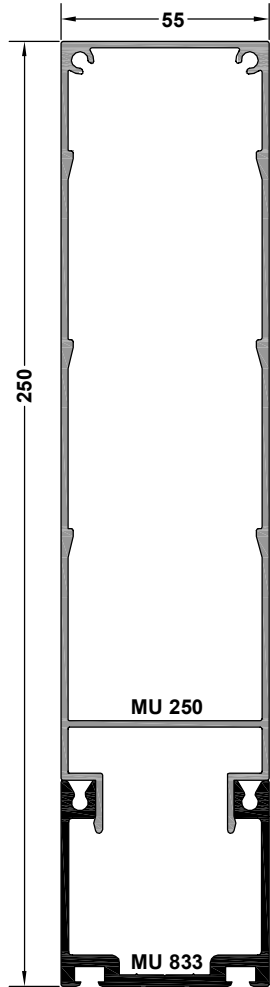
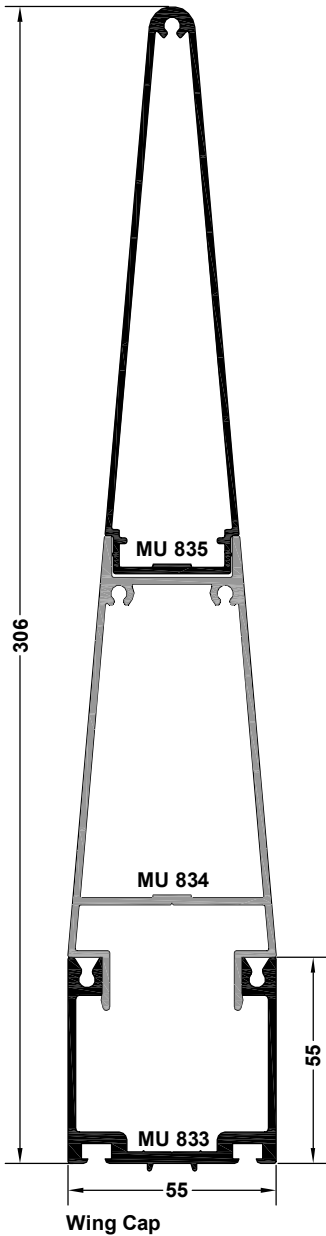
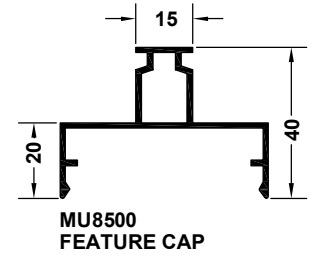
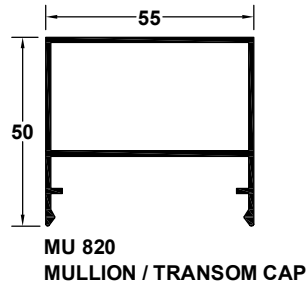
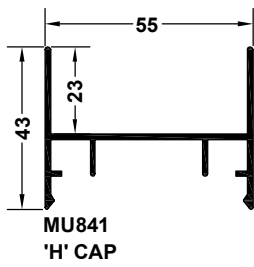
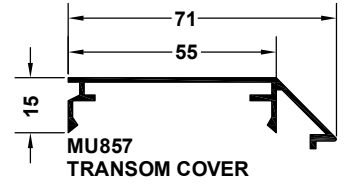
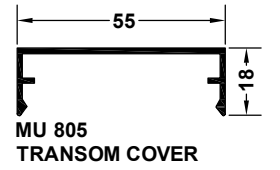
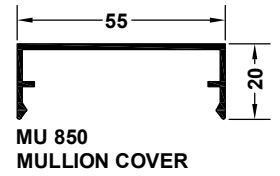
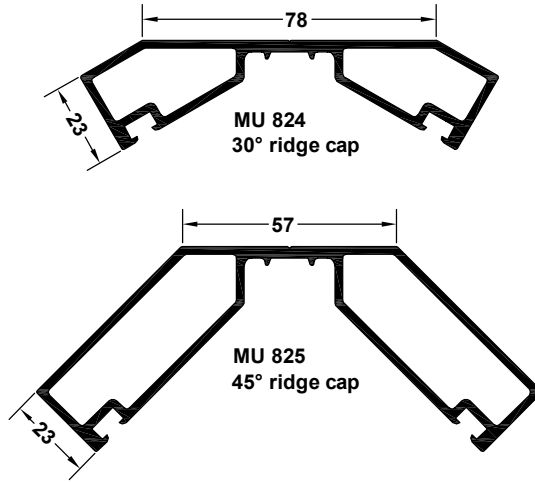
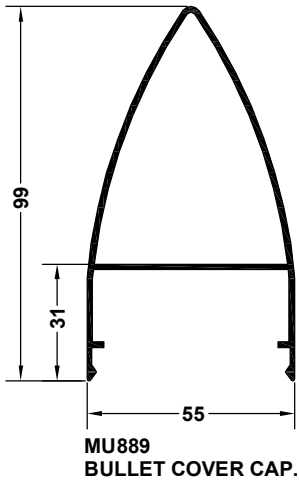

MU 800 SERIES MULLION DRAINED SYSTEM

gaskets and accessories

Scale NTS



G1505
24 / 28mm glazing -
pressure plate gasket
Code - CWG001

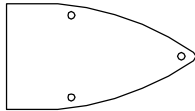

MU899E
End plate for MU899 capping

G1550



Transom sealing/
end gasket
(MU 893)



CWG 010
24 / 28mm glazing -
Transom gasket

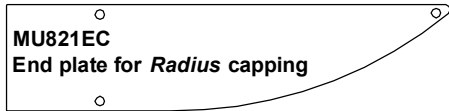

MU821EC
End plate for *Radius* capping



CWG 014
24 / 28mm glazing -
Mullion gasket

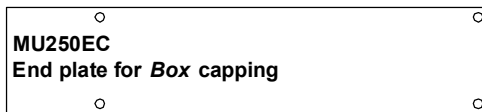

MU250EC
End plate for *Box* capping



G 1501
EPDM Grid
insulator for
24 mm units
Code = CWA001

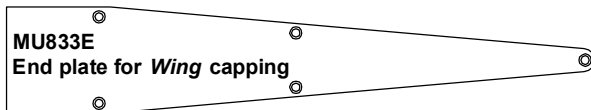

MU833E
End plate for *Wing* capping



CWATB
Isolator for
28mm Units

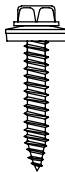

CWA 025
14 x 38 hex head screw
with bonded washer
(28mm glazing). See
drawing 1.1.09 & 10

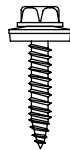

CWA 028
14 x 32 hex head screw
with bonded washer
(6 - 24mm glazing). See
drawing 1.1.09 & 10



CWA 030
No. 8 x 19 tamper
proof transom screw

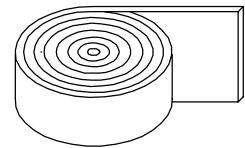

Butyl tape
50mm - CWG003
100mm - CWG004
150mm - CWG005

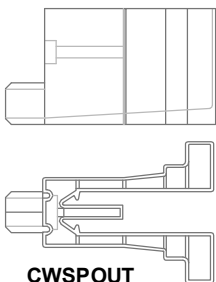

CWSPOUT
Drainage
spout



CWA 031
Drill bit to suit
transom screw



**Stepped drill bit
T 114**

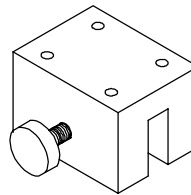

**Mullion Jig
T112**

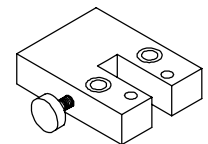

**T 113
Transom Jig**

Heads for punch tool

Small

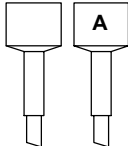

Transom drained
holes for cleats

Medium

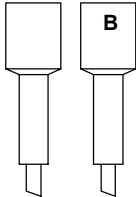

Mullion drained
holes for cleats

Large

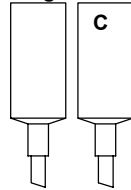

Mullion drained
holes for transom
fixing screws
(Oval head)

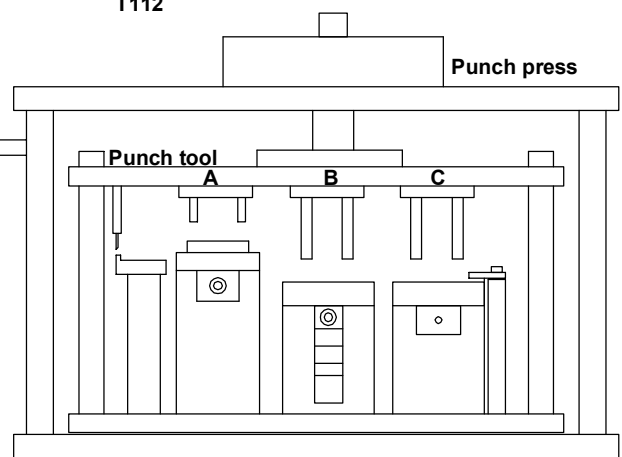
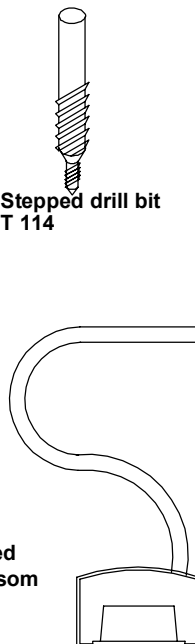

Punch press for curtain wall transoms

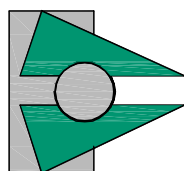

MU 800 SERIES MULLION DRAINED SYSTEM

Accessories

Scale NTS

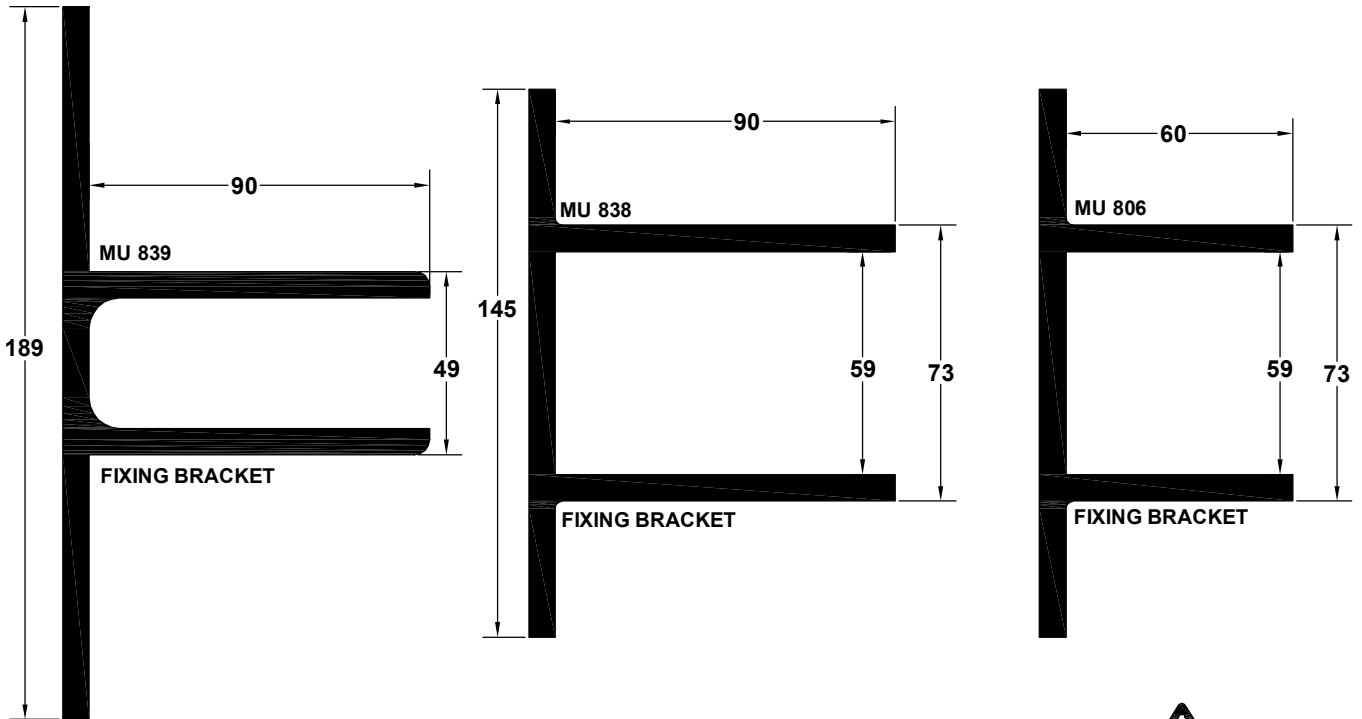

MU 875
11.5mm GLAZING
ADAPTER

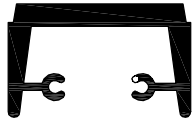

MU 844 Cleat (Bar length)
CWA019 - 57mm cleat (MU883)
CWA020 - 72mm cleat (MU896)
CWA021 - 101mm cleat (MU894 & MU899)

(For transom spans over 2.5m and/or glass weight is more than 100Kg's, use support cleats)

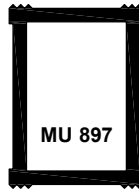

MU 897
lxx = cm4
Mullion joint sleeve
(to suit MU 892)

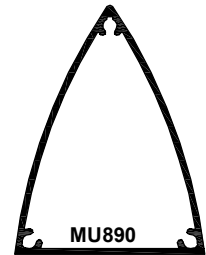

MU 890
Joint sleeve to
suit MU 889



MU 848
6mm GLAZING
ADAPTER

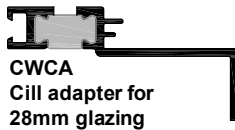

CWCA
Cill adapter for
28mm glazing

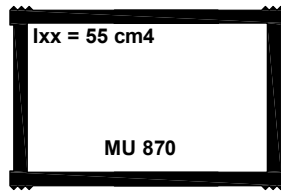

lxx = 55 cm4
MU 870
Mullion joint sleeve
(to suit MU 895)

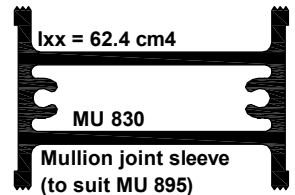

lxx = 62.4 cm4
MU 830
Mullion joint sleeve
(to suit MU 895)



MU 868
14.5mm GLAZING
ADAPTER

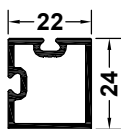

CWAC
channel closer to
suit 24mm units

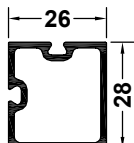

CWAC28
channel closer to suit
28mm units

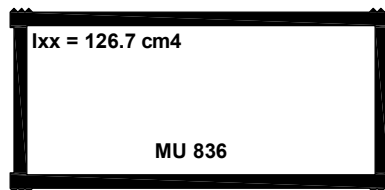

lxx = 126.7 cm4
MU 836
Mullion joint sleeve
(to suit MU 882)

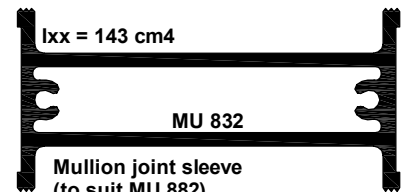

lxx = 143 cm4
MU 832
Mullion joint sleeve
(to suit MU 882)

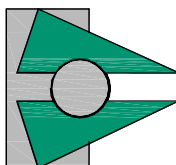

MU 800 SERIES MULLION DRAINED SYSTEM

Brackets

Scale NTS

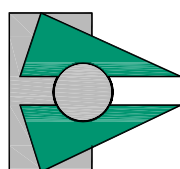
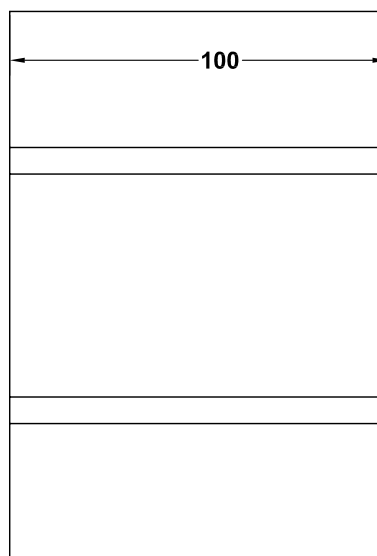
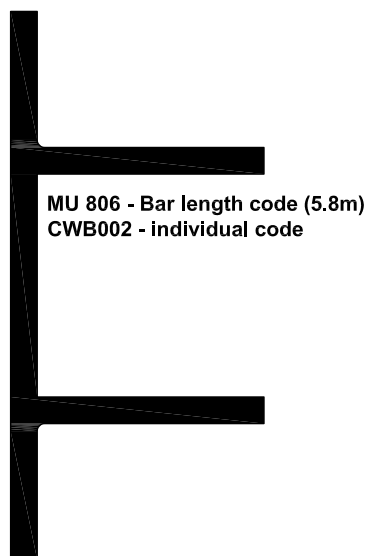
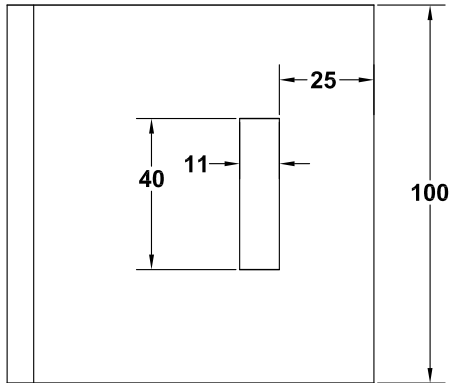
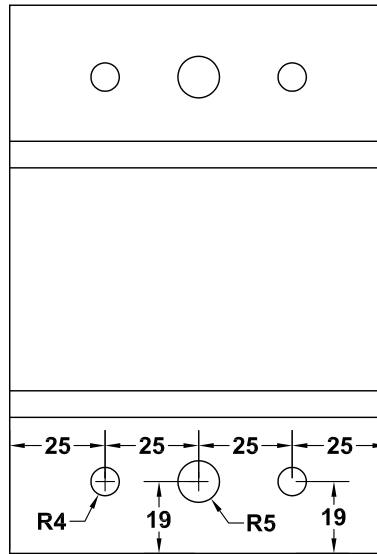
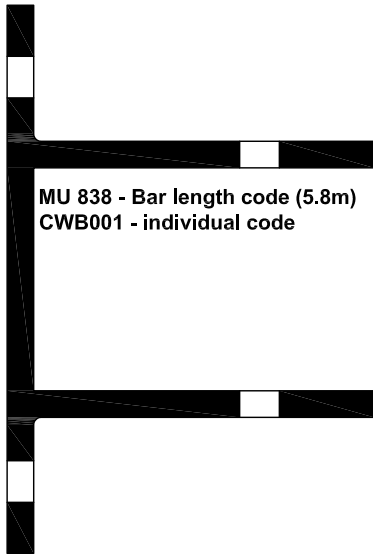

MU 800 SERIES MULLION DRAINED SYSTEM

lxx values for mullions with sleeve
scale NTS

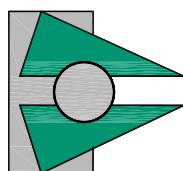
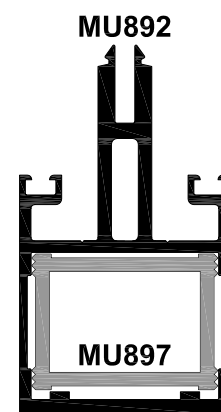
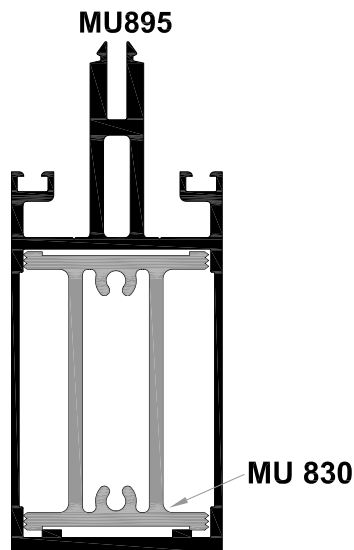
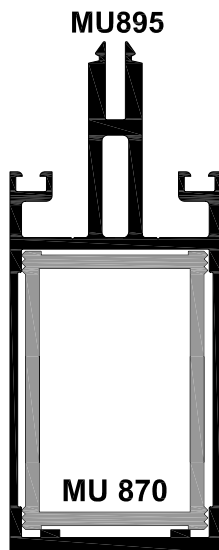
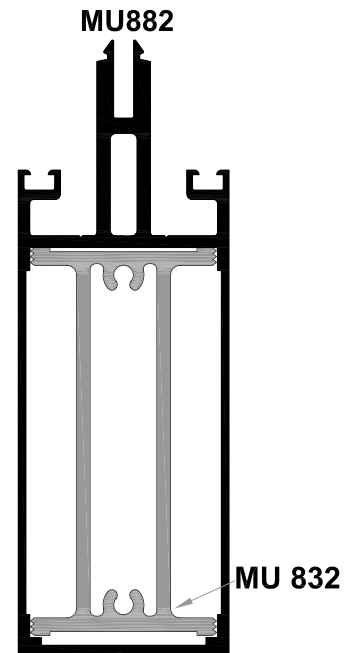
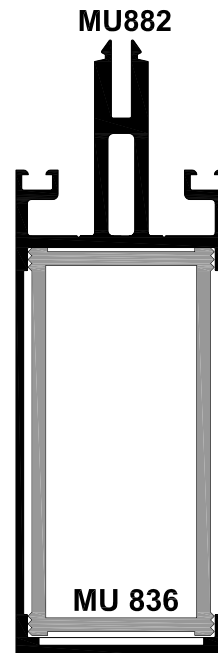
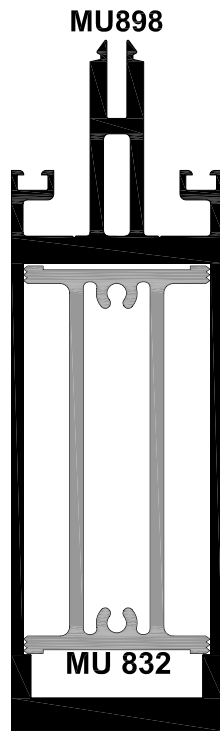
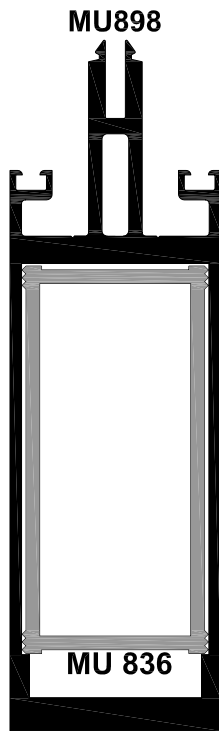

MU 800 SERIES MULLION DRAINED SYSTEM

Profile assembly

Scale NTS

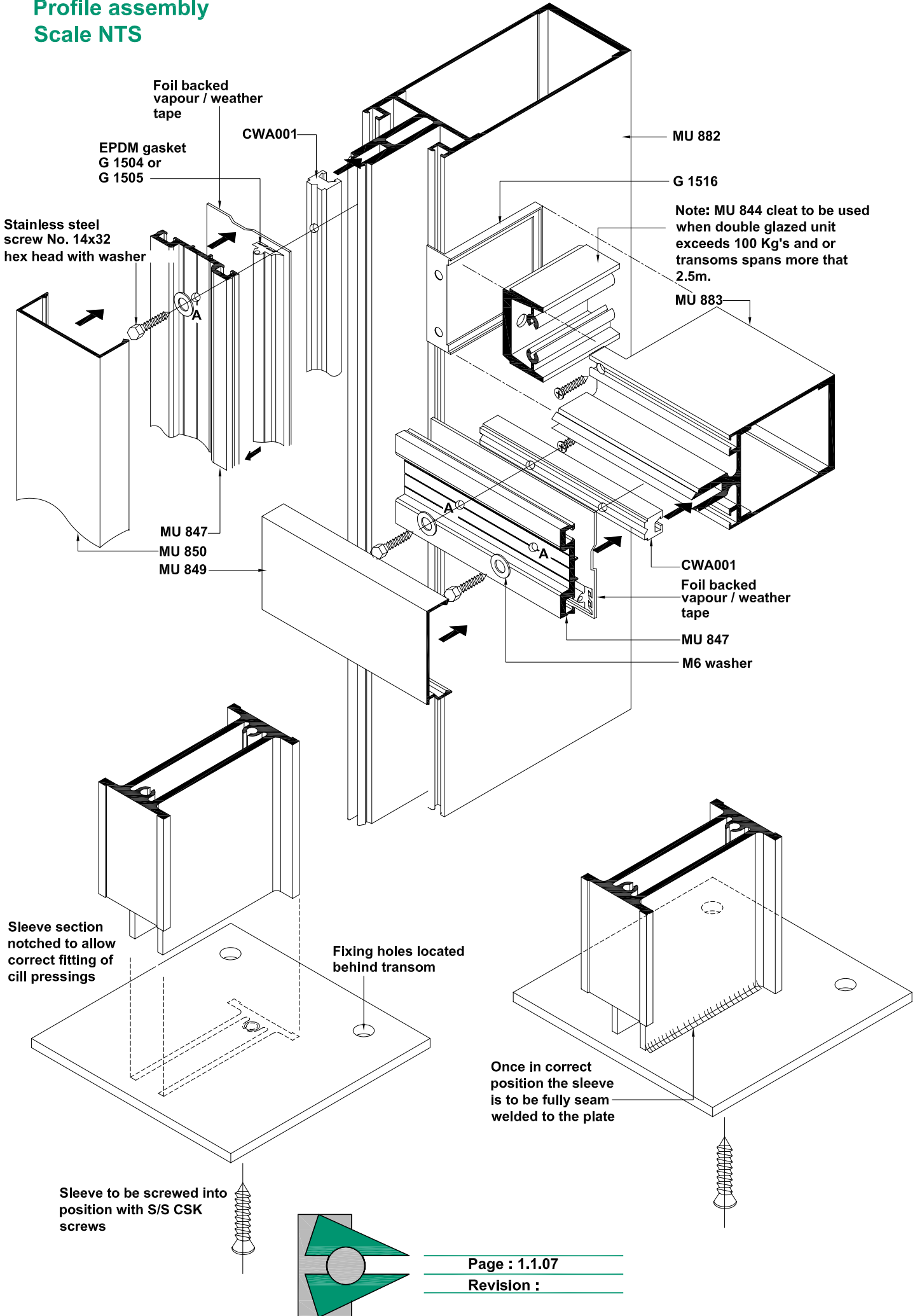

MU 800 SERIES MULLION DRAINED SYSTEM

Capping assembly

Scale NTS

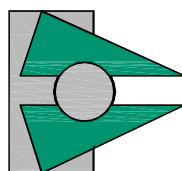
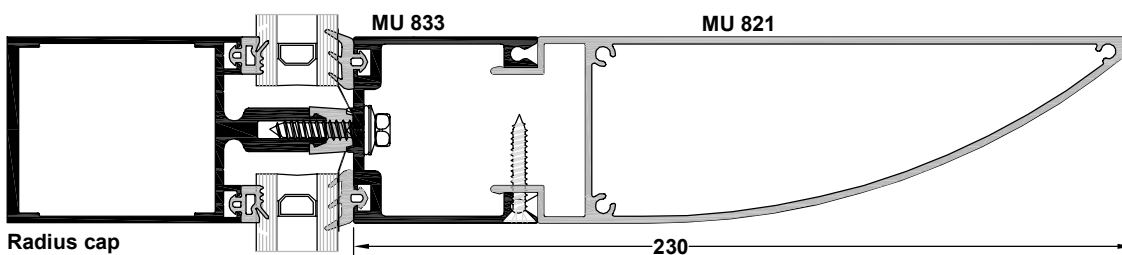
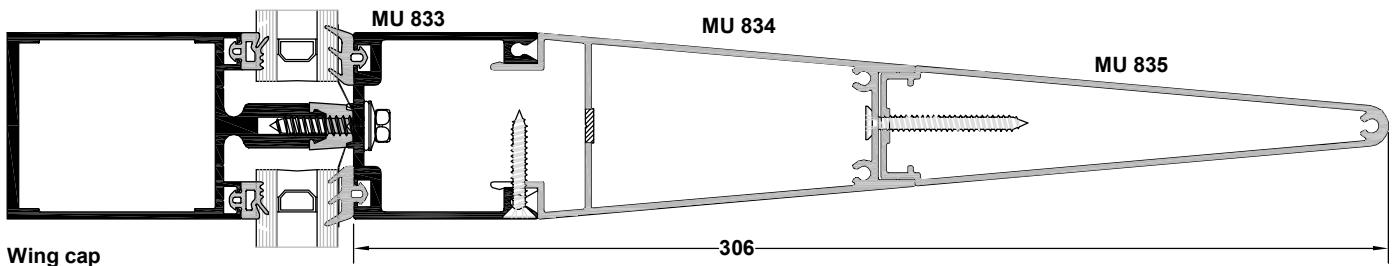
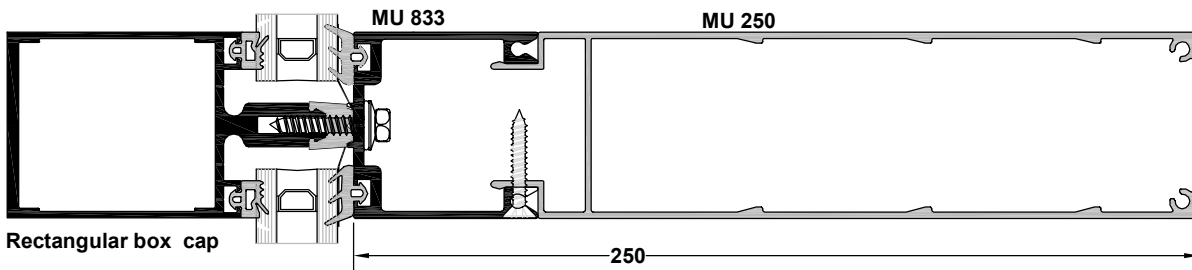
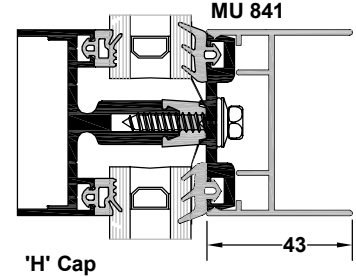
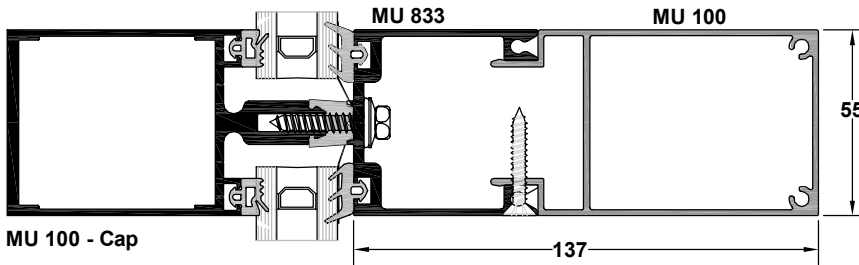
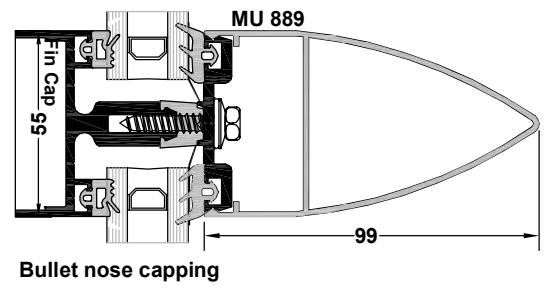
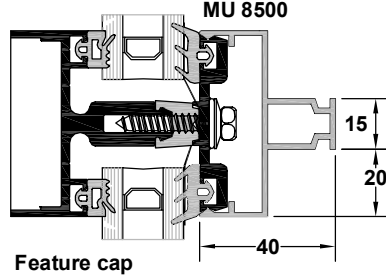
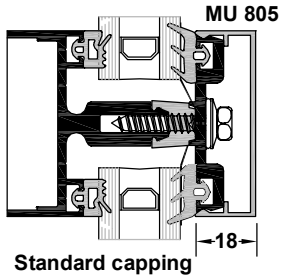
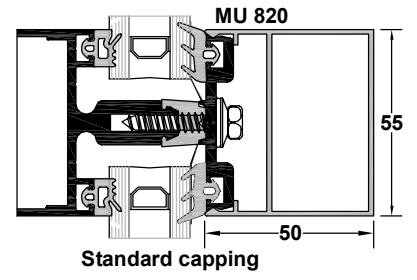
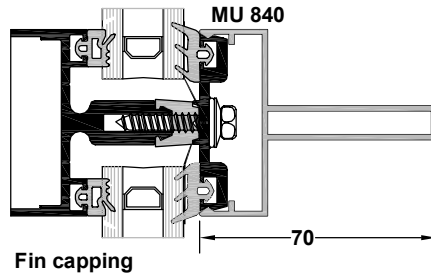
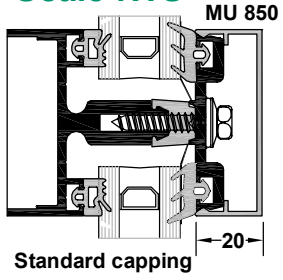

MU 800 SERIES MULLION DRAINED SYSTEM

Mullion assembly for double / single glazing

Scale NTS

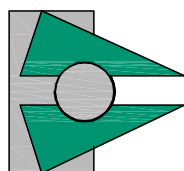
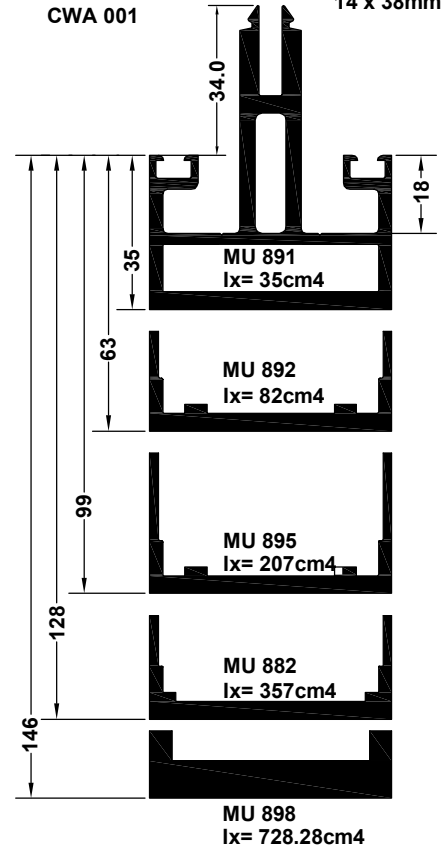
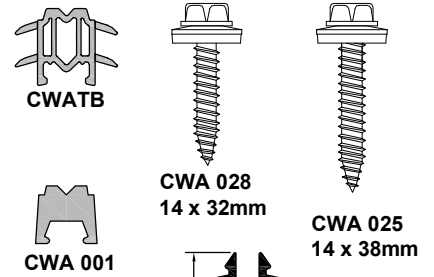
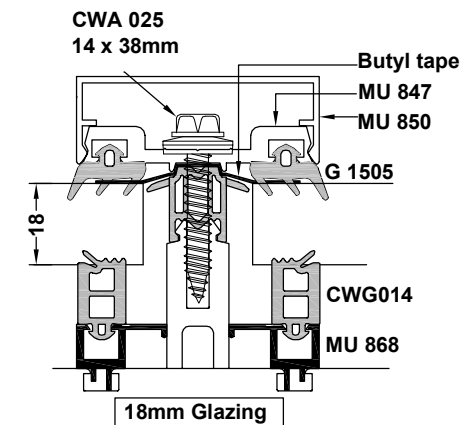
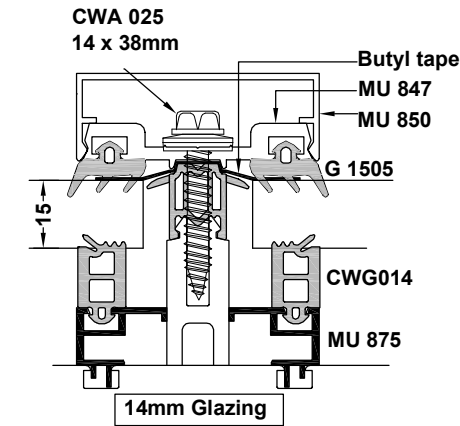
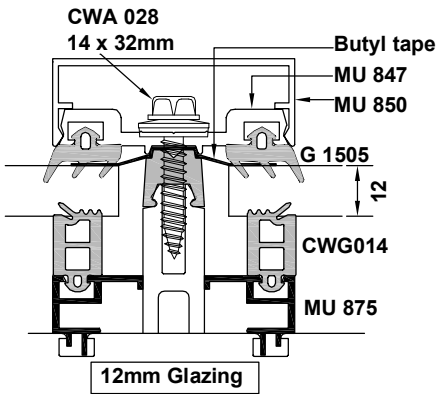
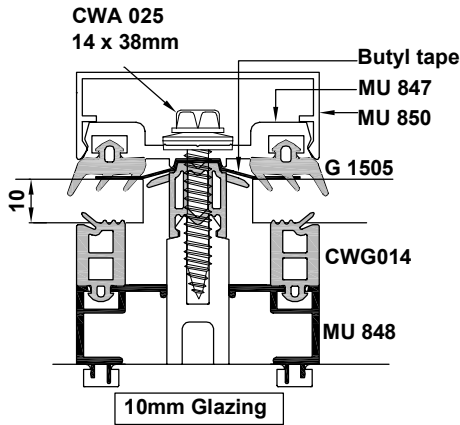
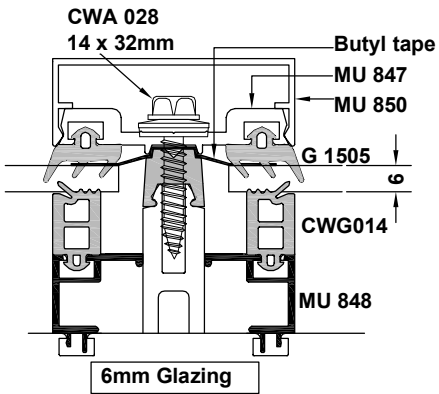
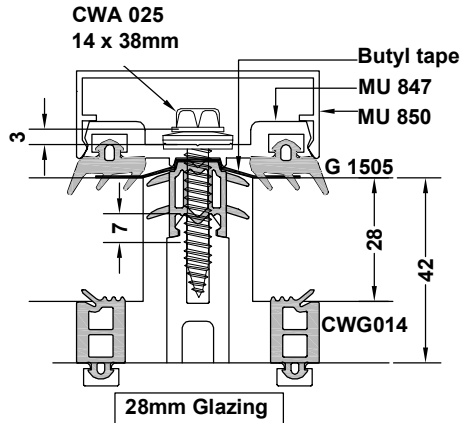
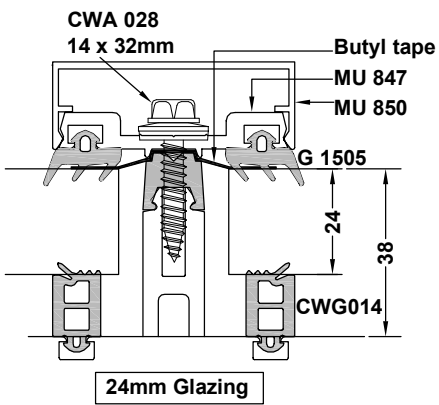

MU 800 SERIES MULLION DRAINED SYSTEM

Transom assembly for double / single glazing

Scale NTS

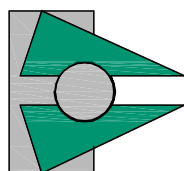
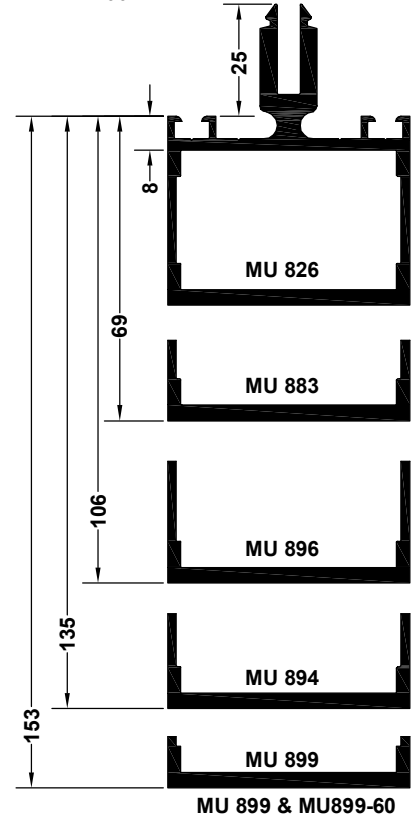
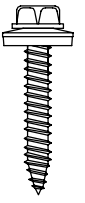
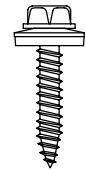
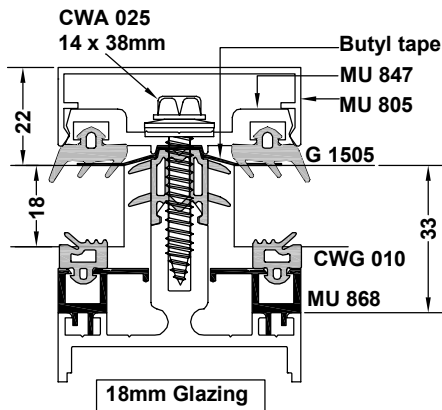
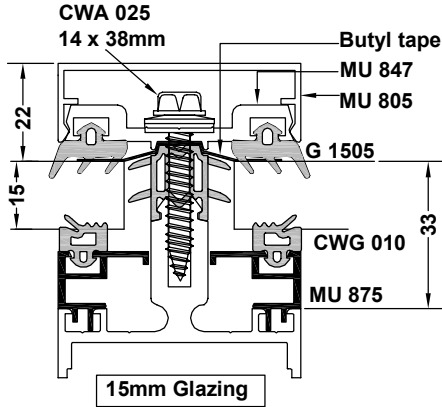
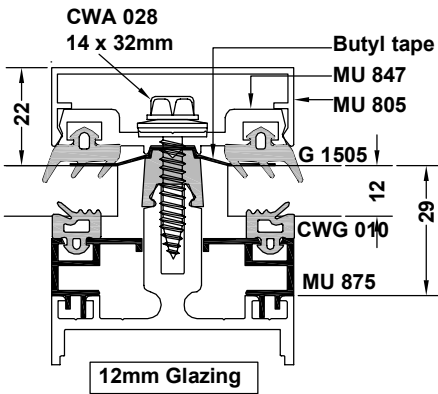
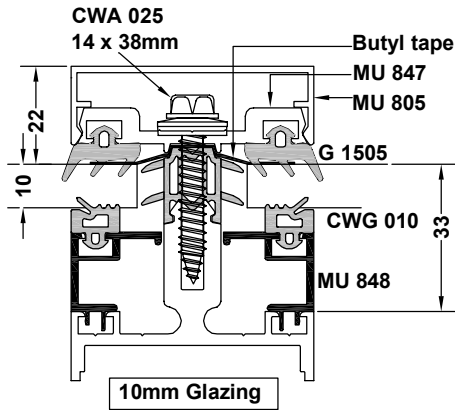
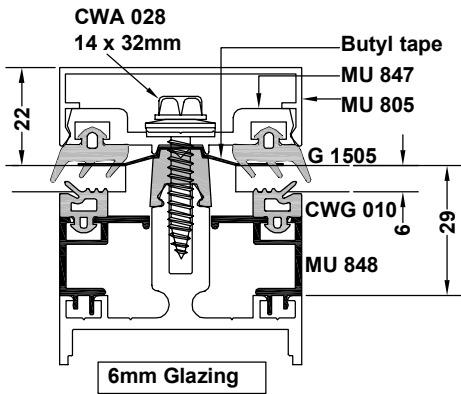
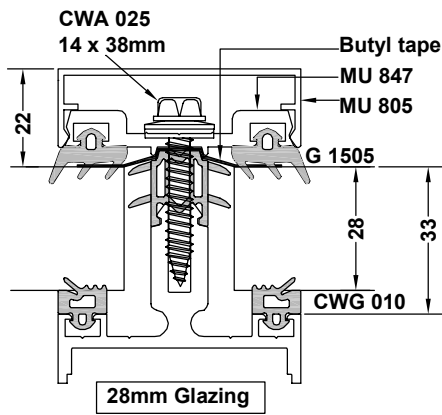
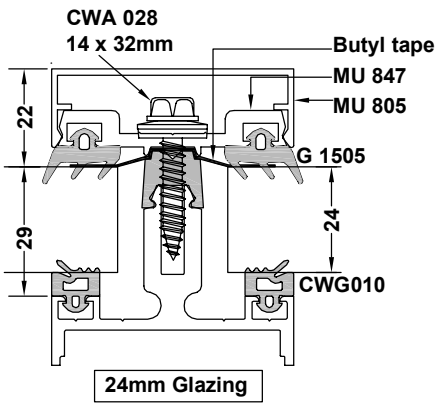

MU 800 SERIES MULLION DRAINED SYSTEM

Profile applications

Scale NTS

**Curtain
walling**

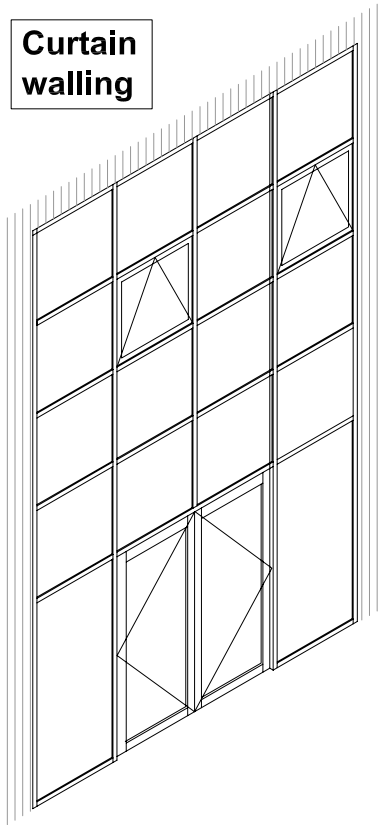

Sloped glazing

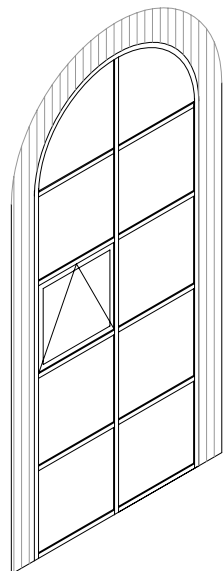
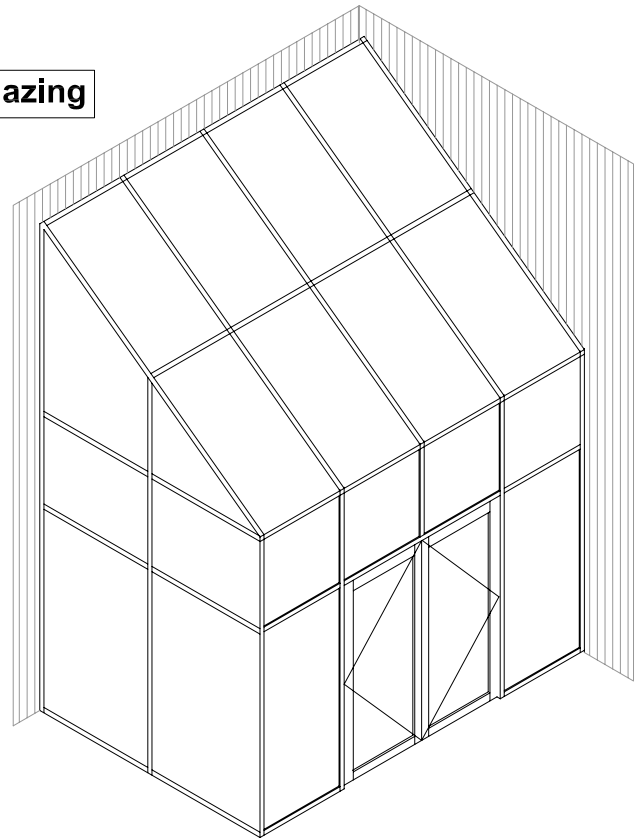

Arched heads

Rooflights

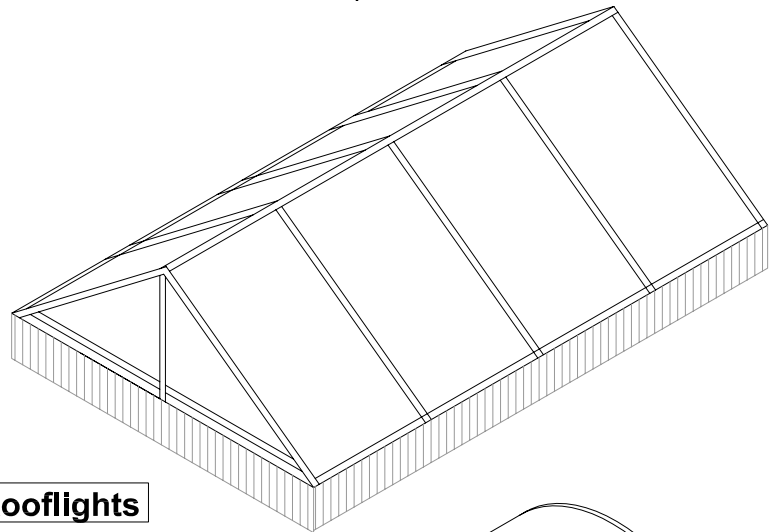

Rooflights

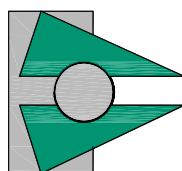
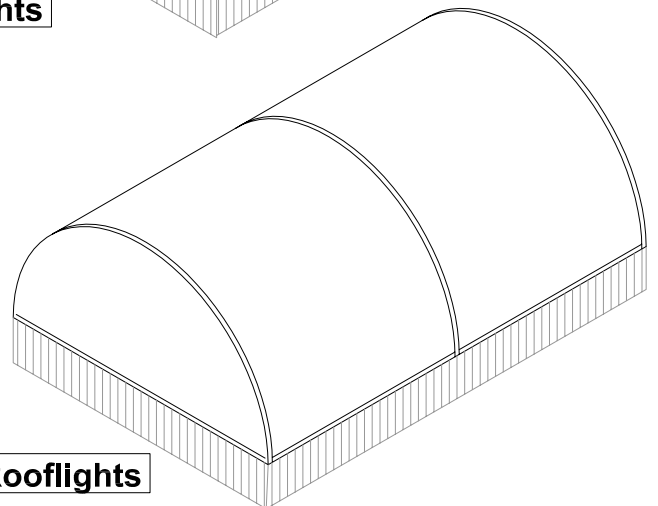

MU 800 SERIES MULLION DRAINED SYSTEM

Typical head detail

Scale 1:2

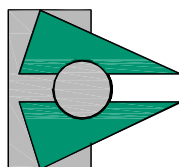
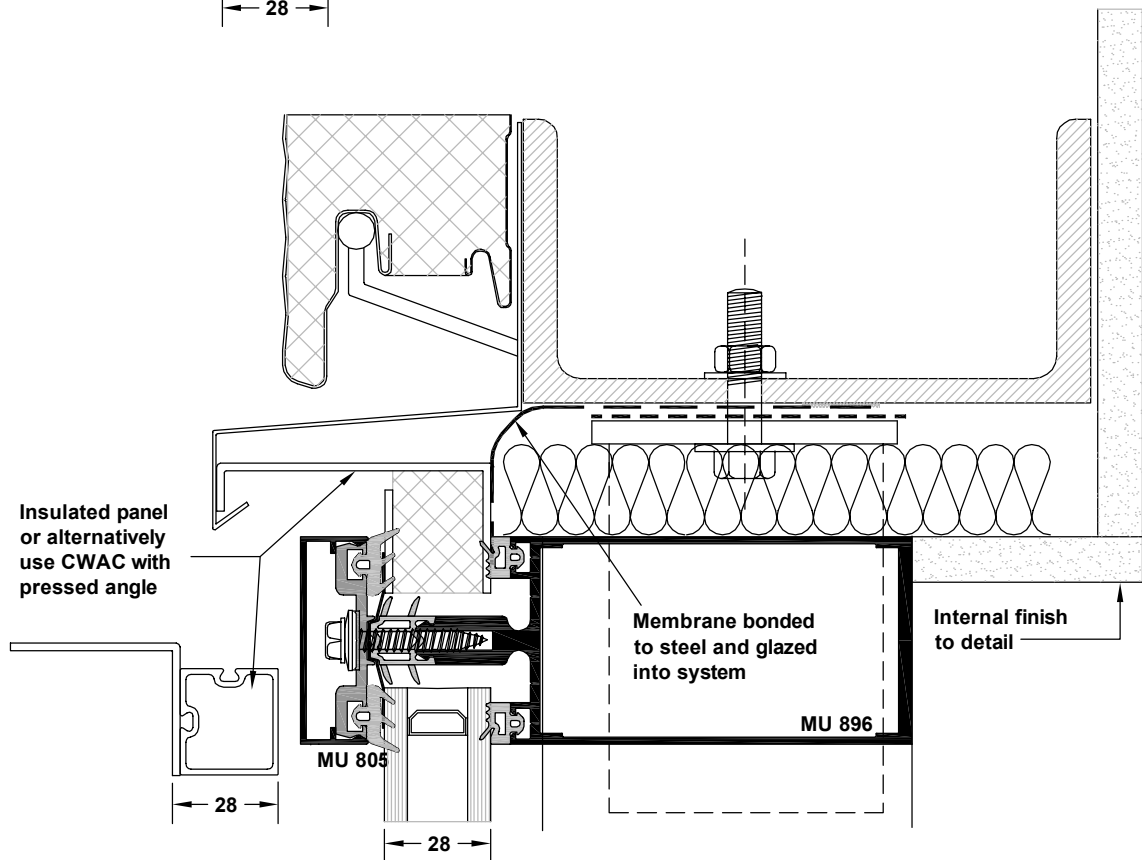
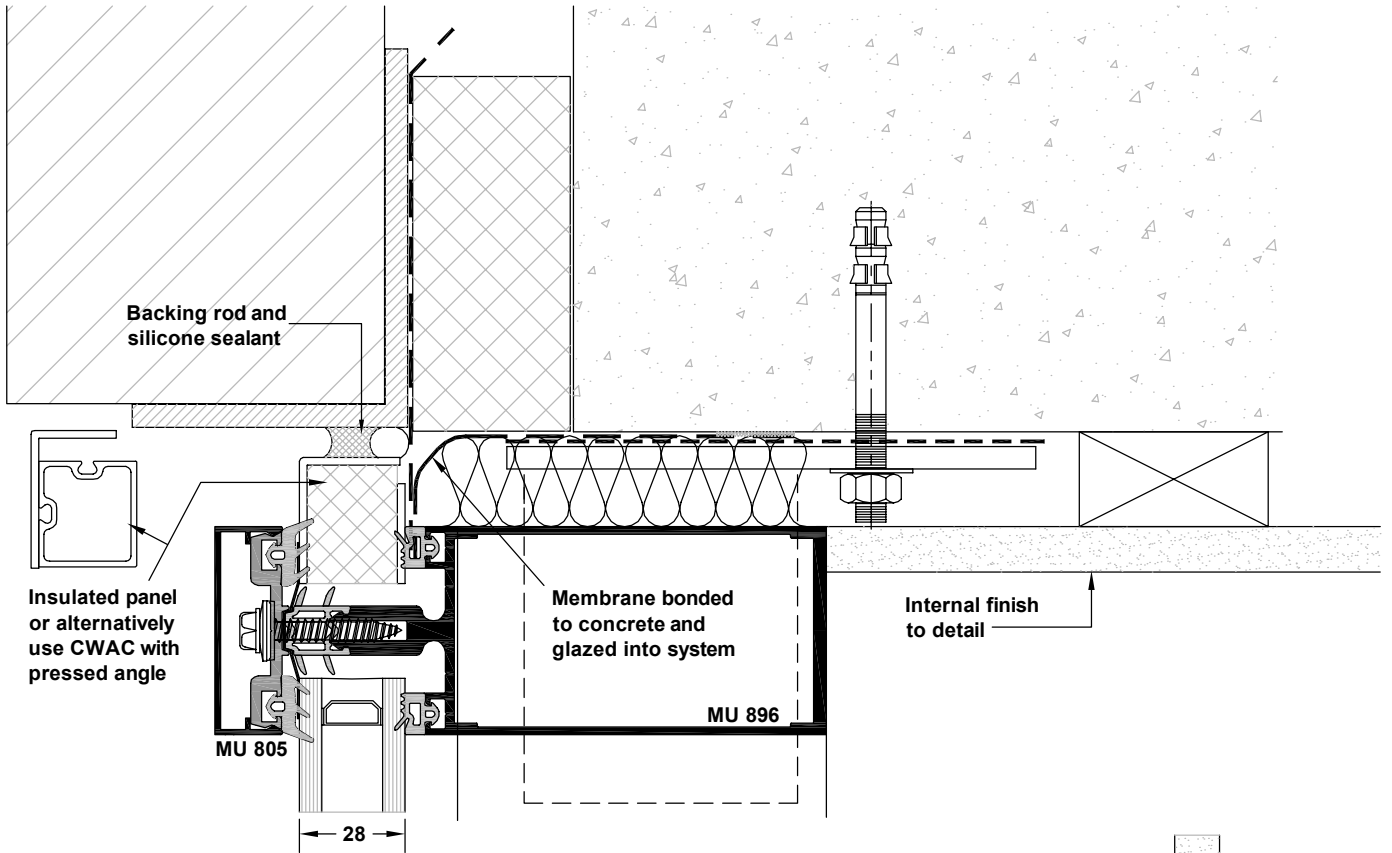

MU 800 SERIES MULLION DRAINED SYSTEM

Typical head detail

Scale 1:2

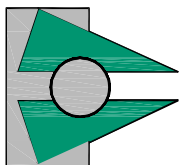
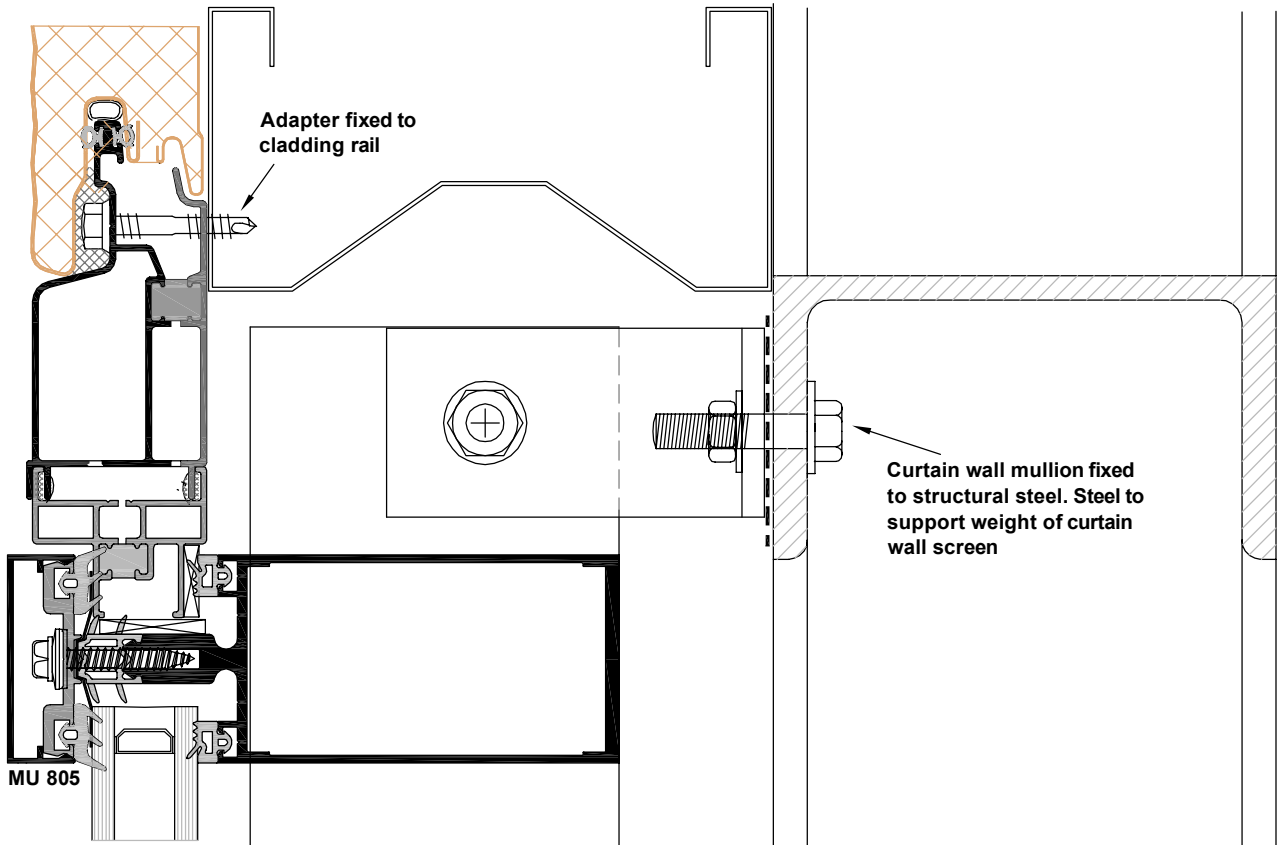
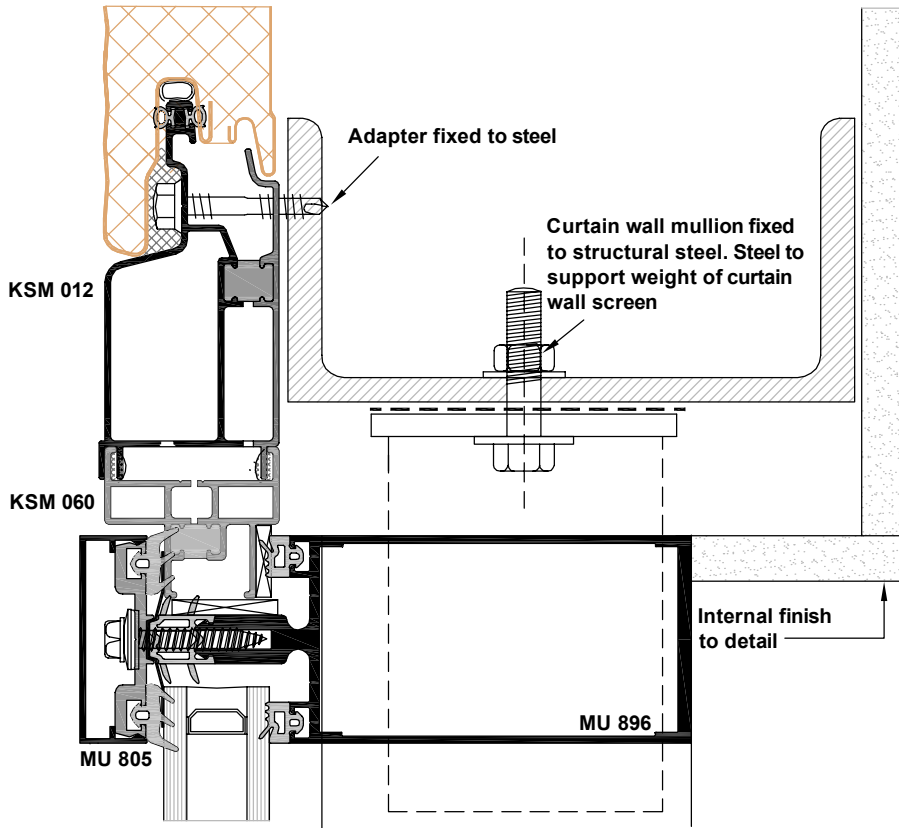

MU 800 SERIES MULLION DRAINED SYSTEM

Typical cill detail

Scale 1:2

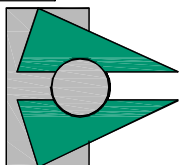
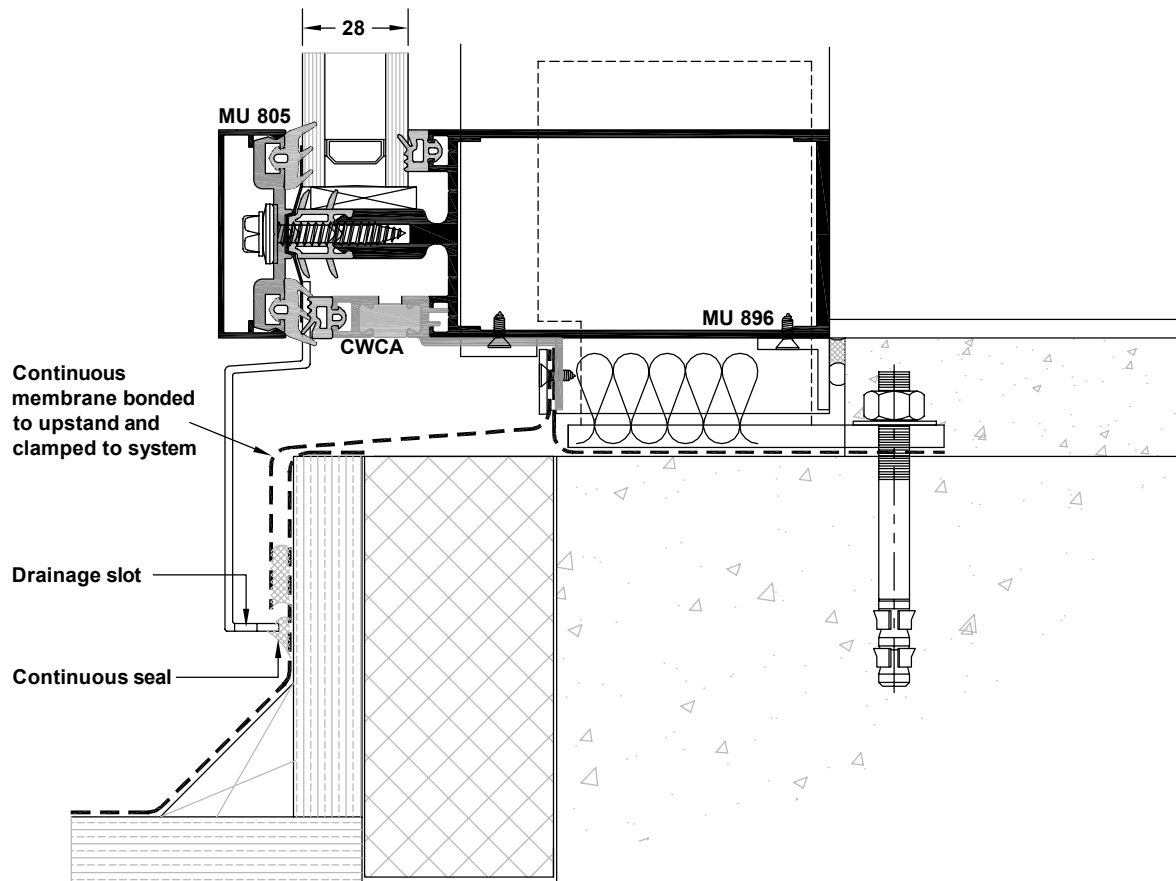
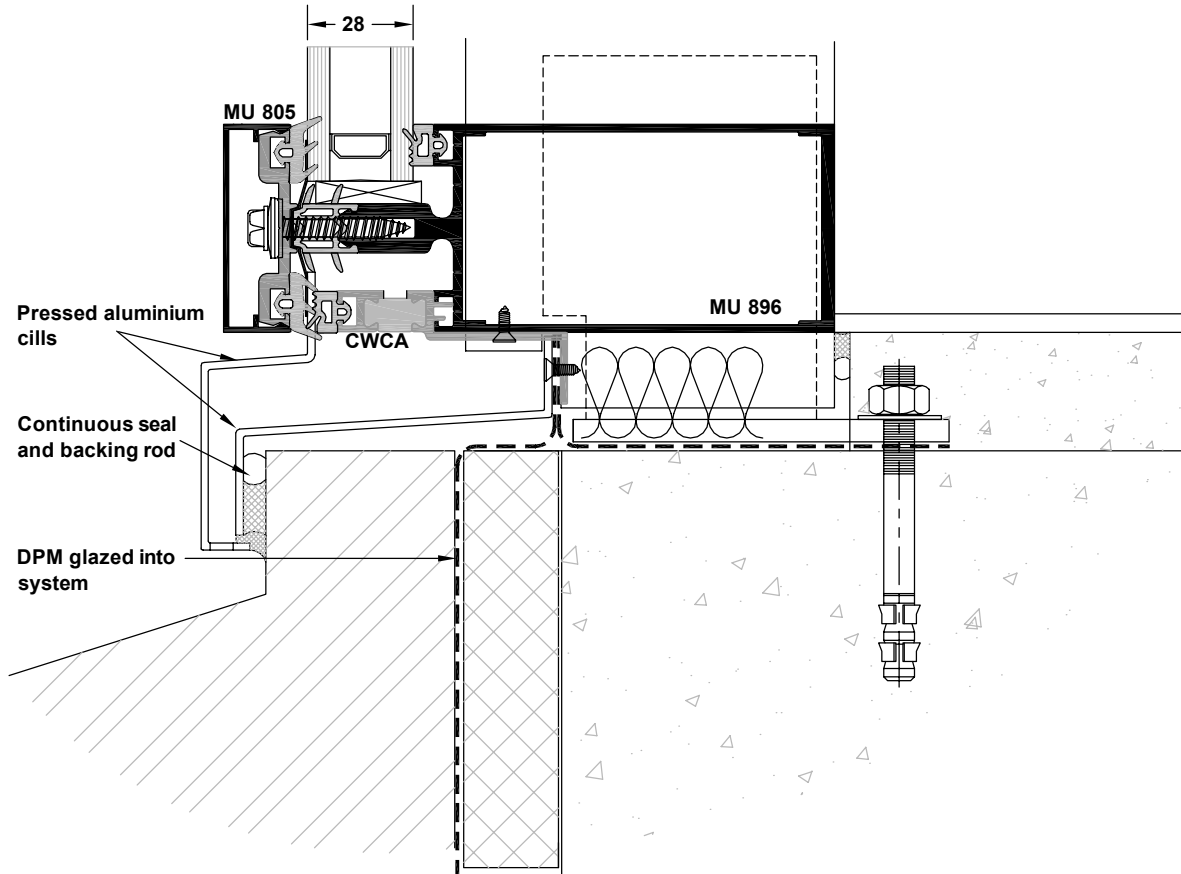

MU 800 SERIES MULLION DRAINED SYSTEM

Typical fixing detail

Scale 1:2

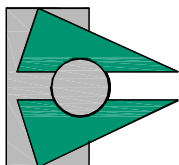
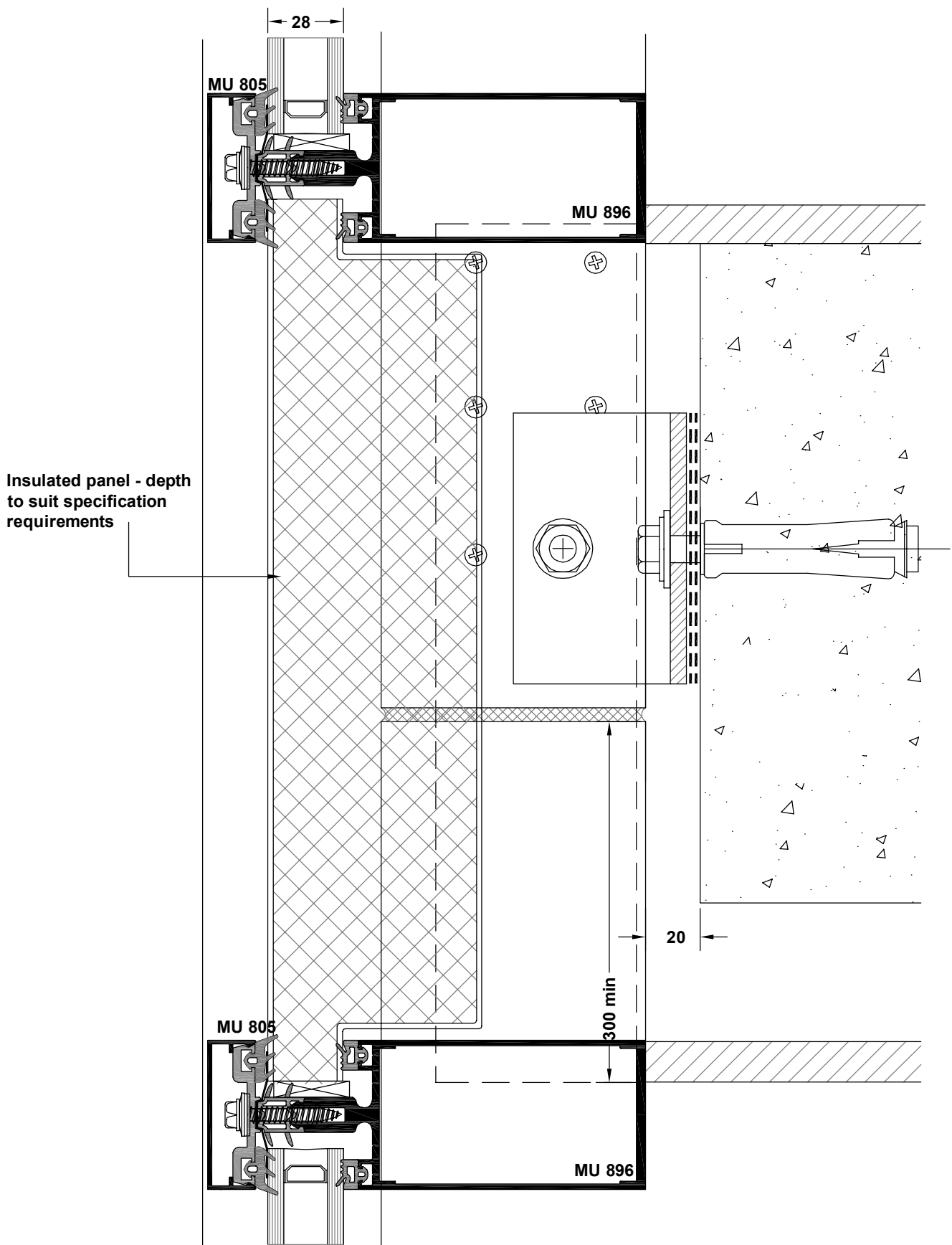

MU 800 SERIES MULLION DRAINED SYSTEM

Typical fixing detail

Scale 1:2

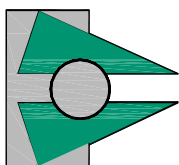
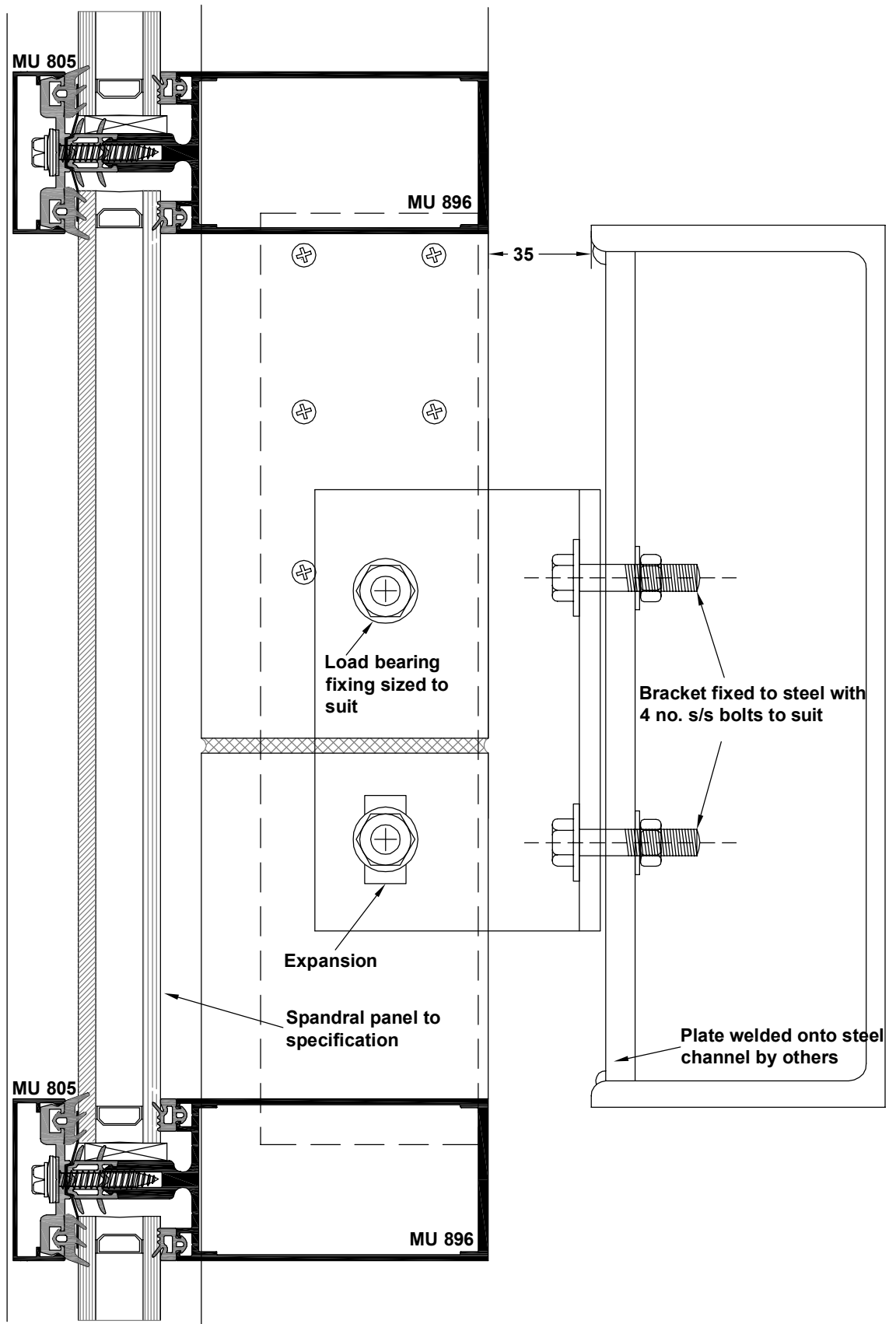

MU 800 SERIES MULLION DRAINED SYSTEM

Typical vent detail - 24mm glazing

Scale 1:2

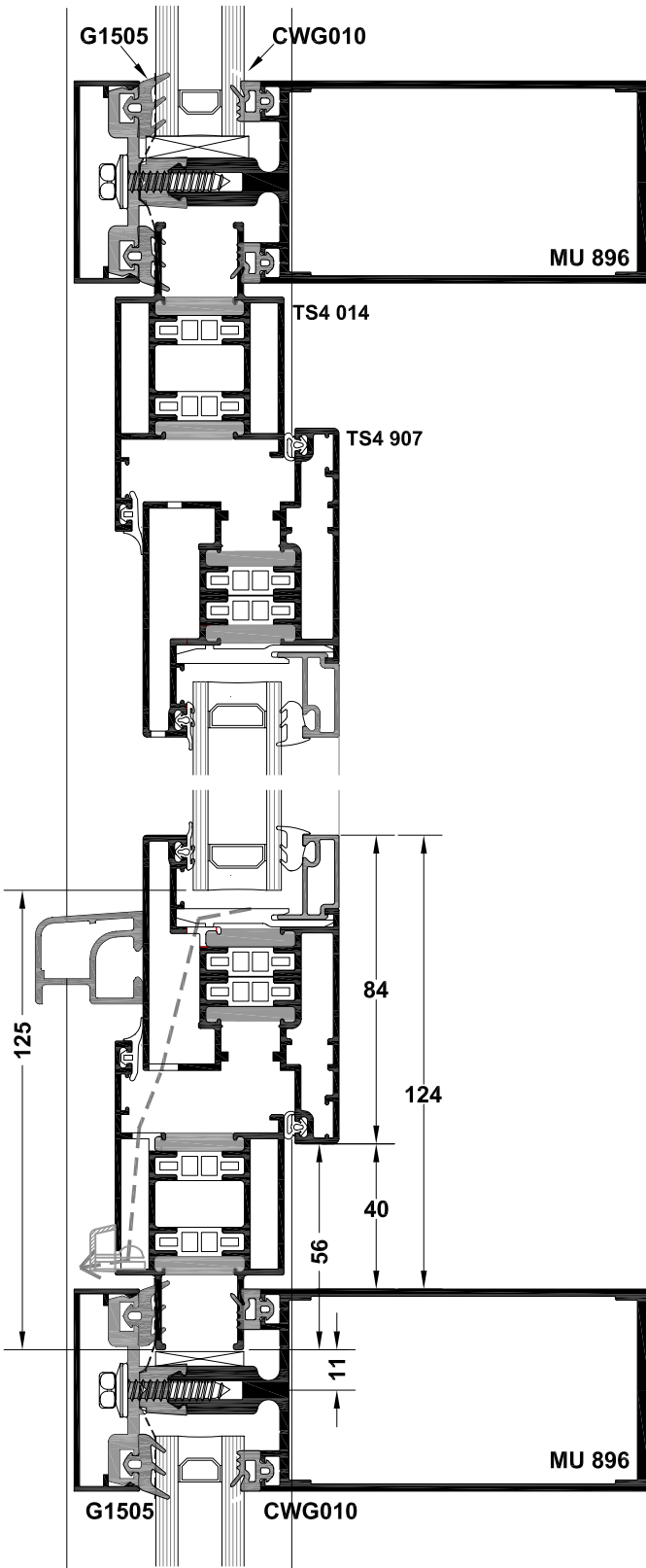

TS46 tilt and turn into C/W

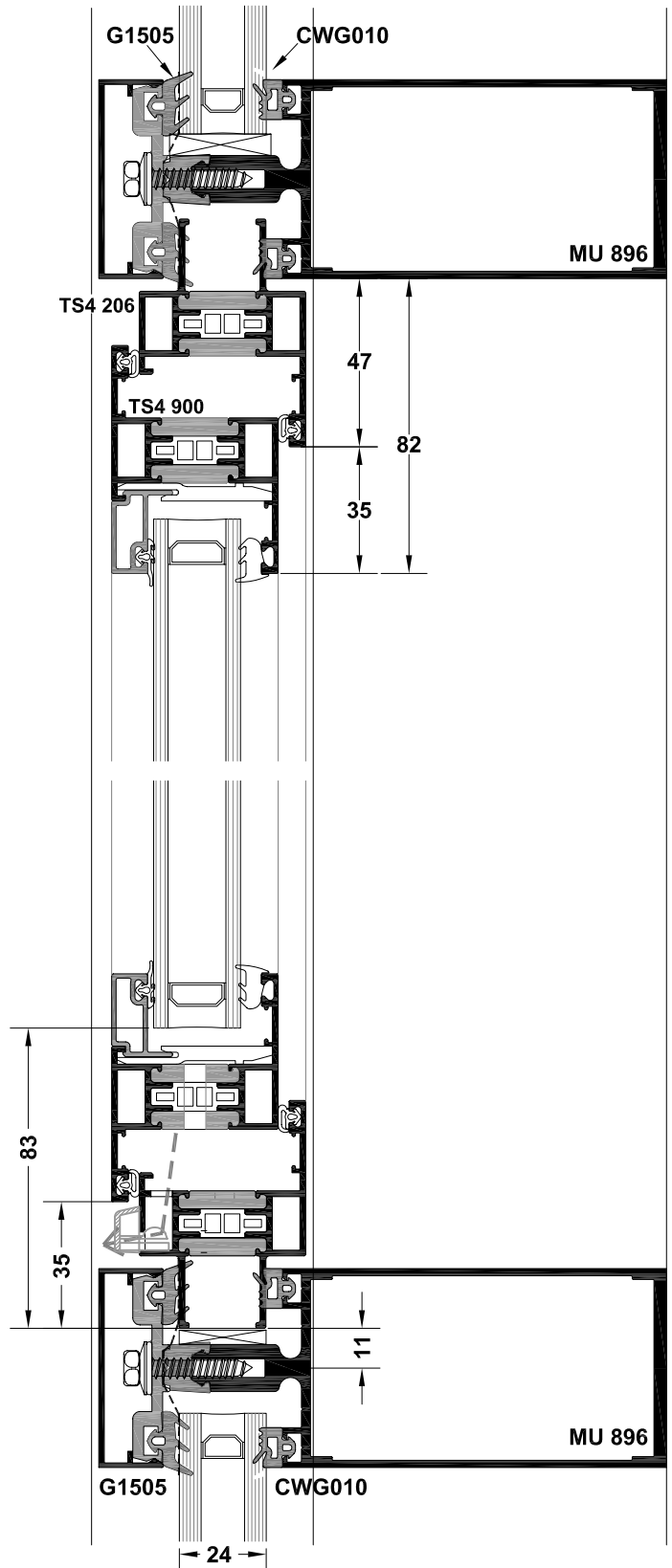

TS46 casement into C/W

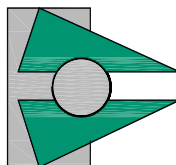

MU 800 SERIES MULLION DRAINED SYSTEM

Concealed vent

Scale 1:2

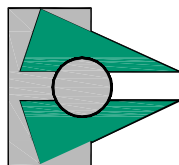
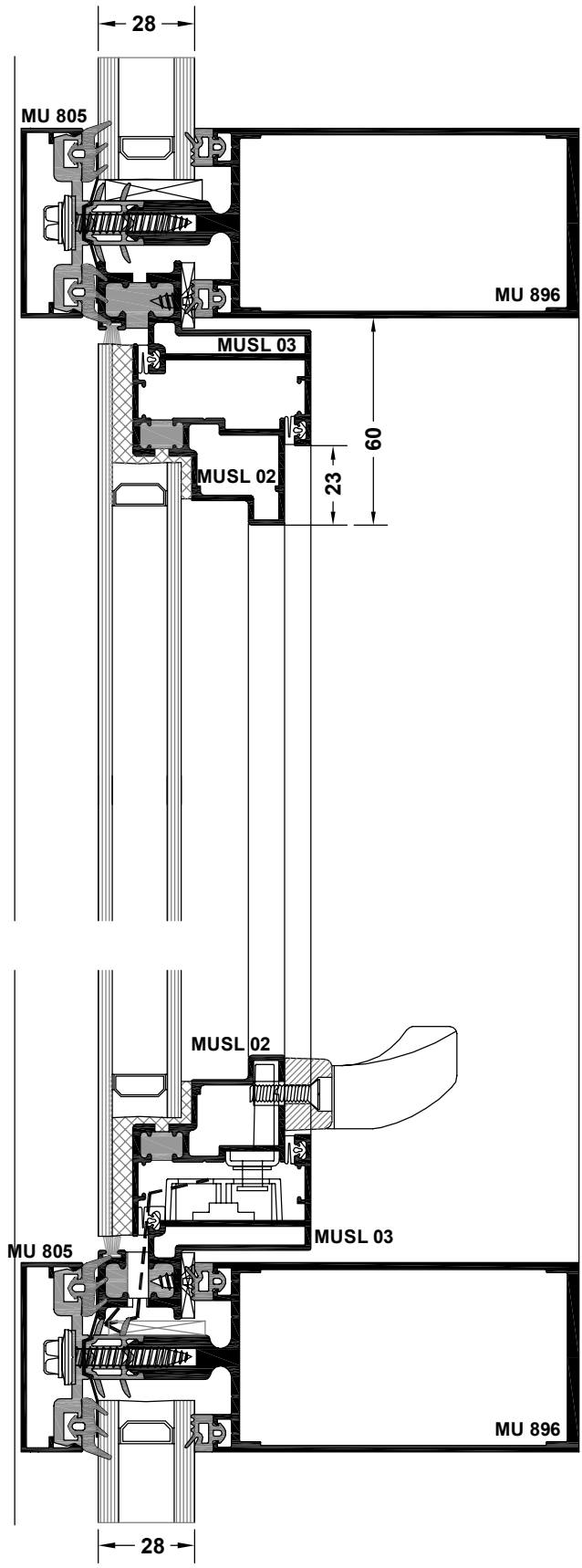
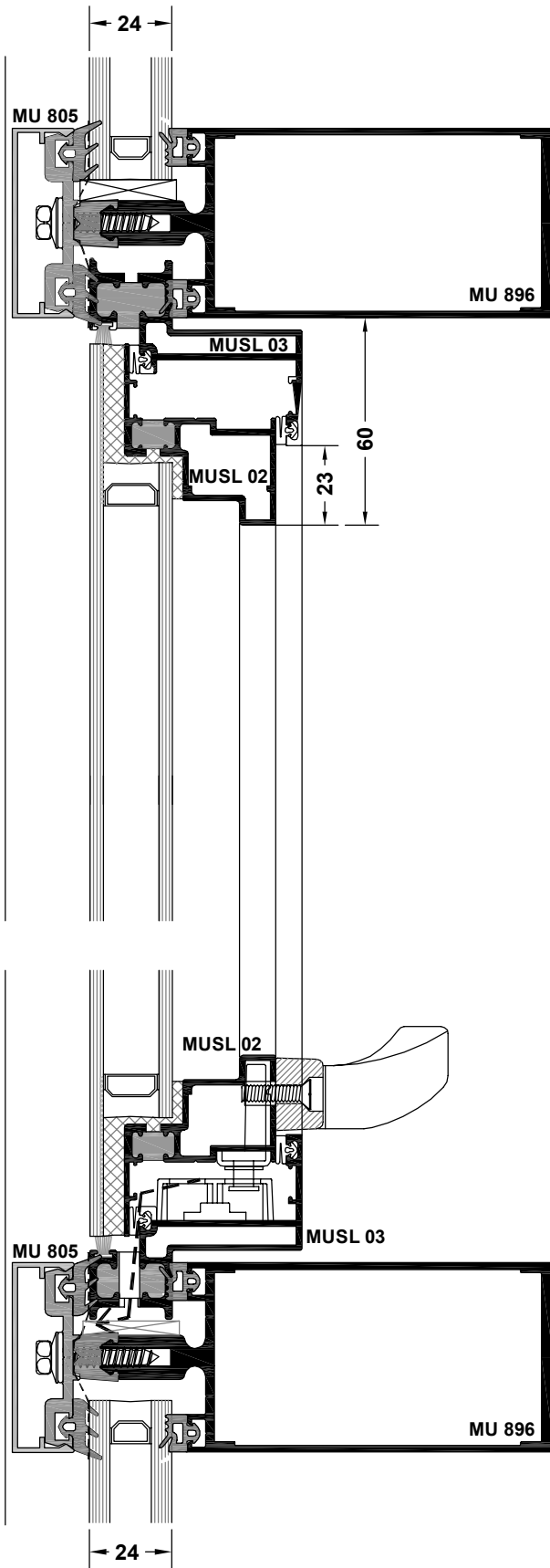

MU 800 SERIES MULLION DRAINED SYSTEM

Typical vent detail - 28mm glazing

Scale 1:2

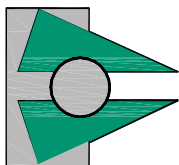
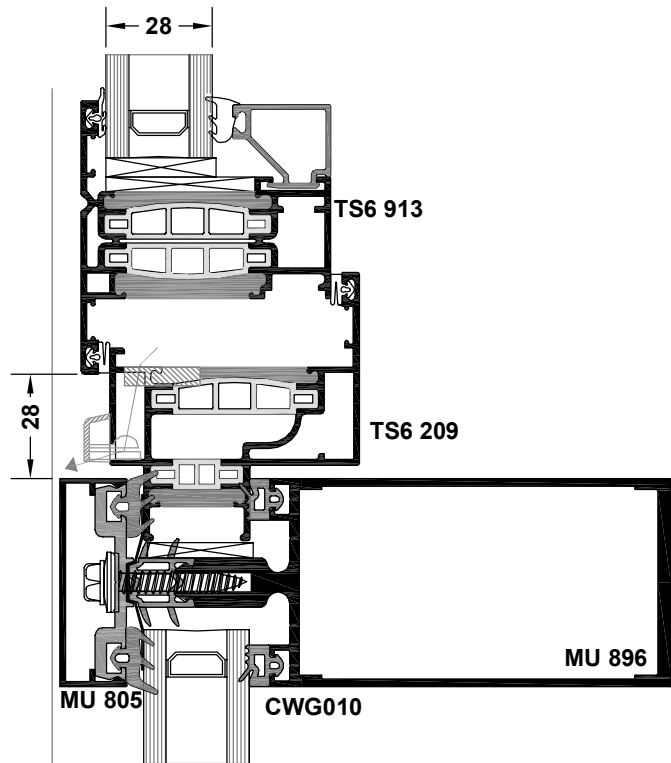
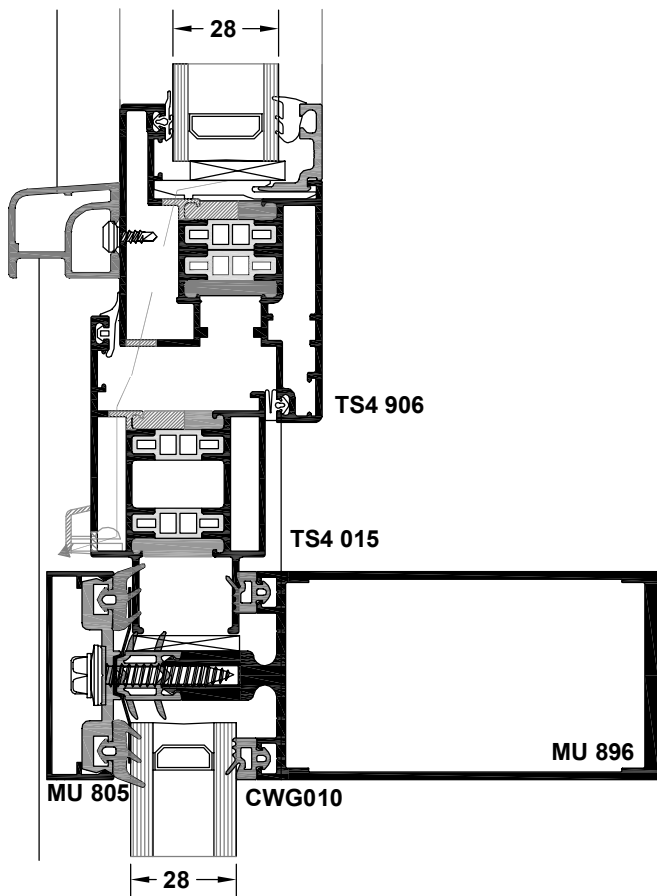
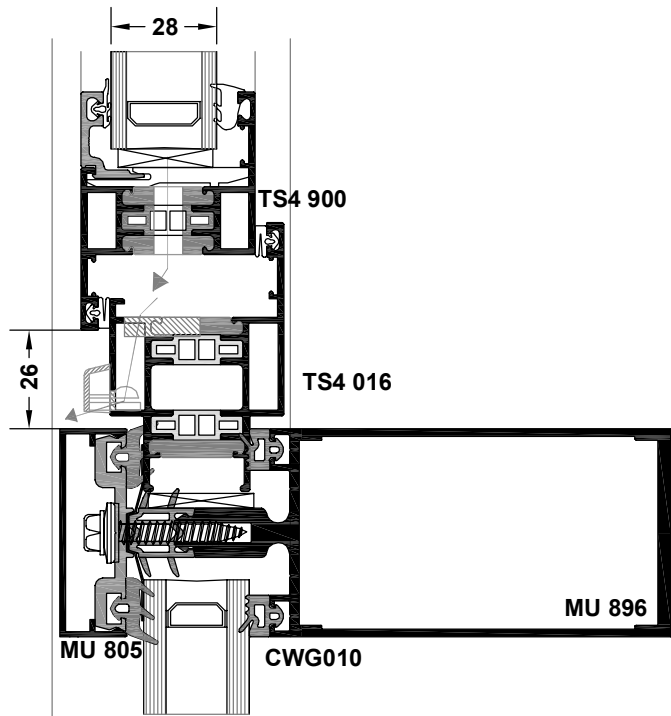
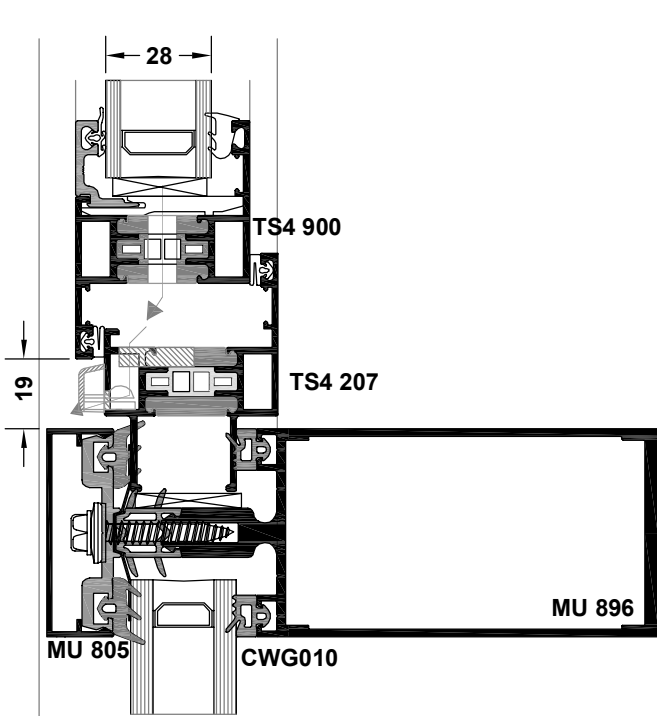

MU 800 SERIES MULLION DRAINED SYSTEM

Typical door head detail

Scale 1:2

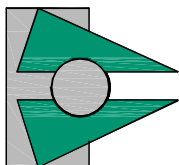
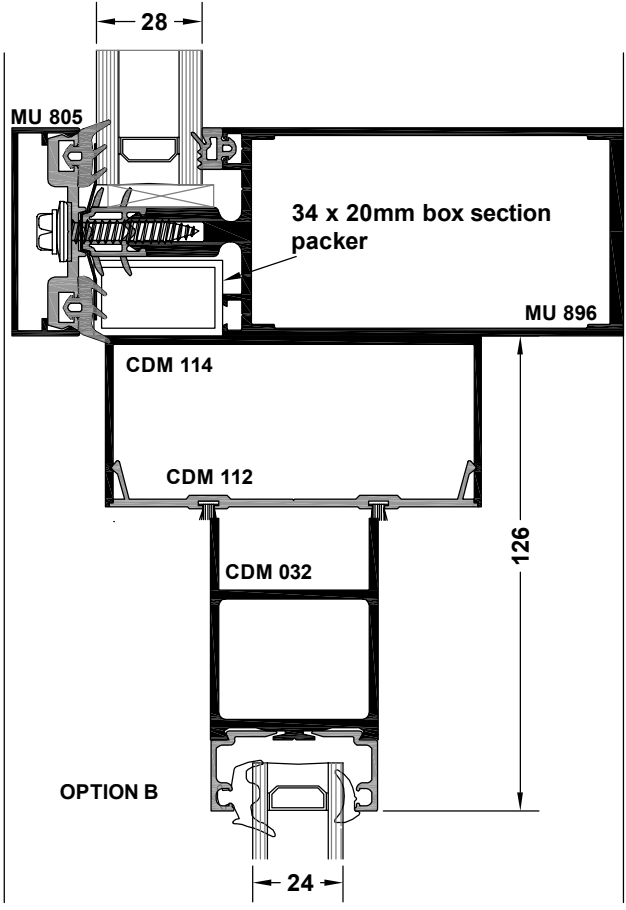
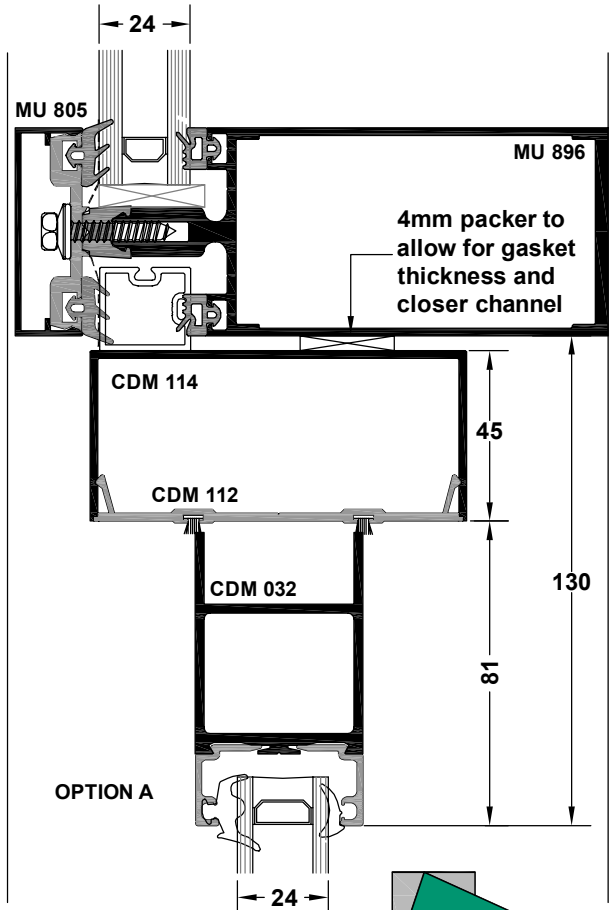
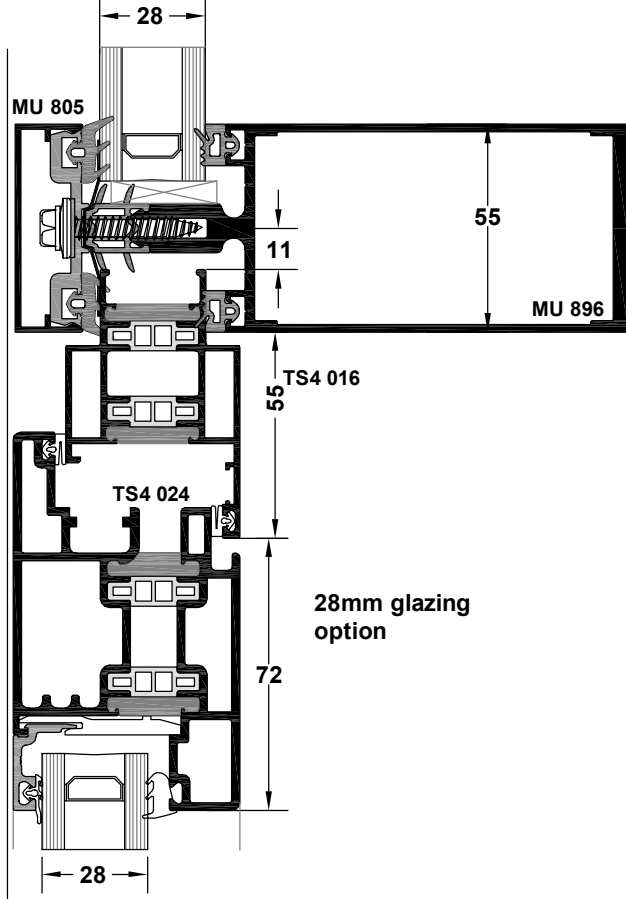
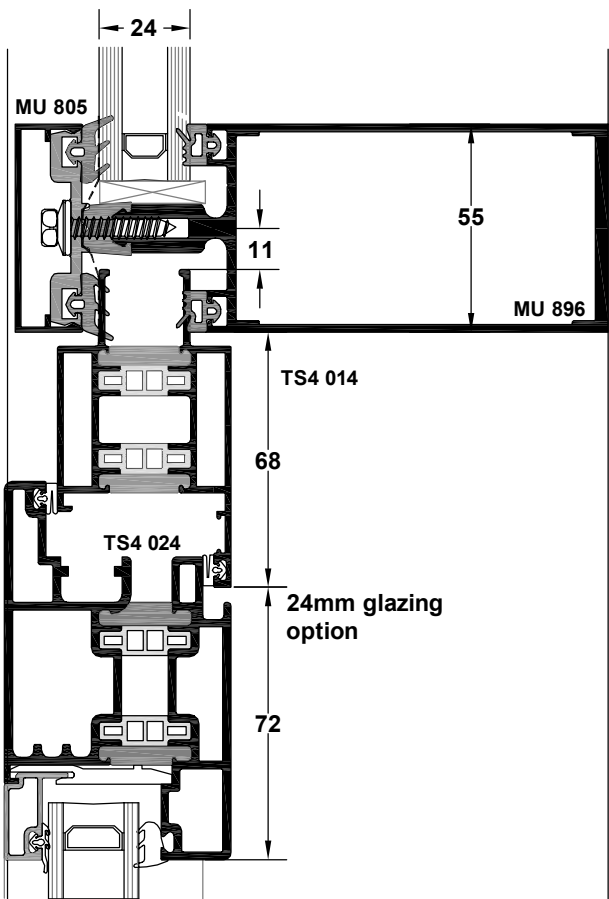

Section 1.1.20

Revision : B (-/-/-)

MU 800 SERIES MULLION DRAINED SYSTEM

Typical jamb detail

Scale 1:2

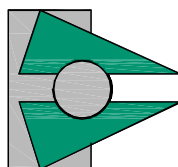
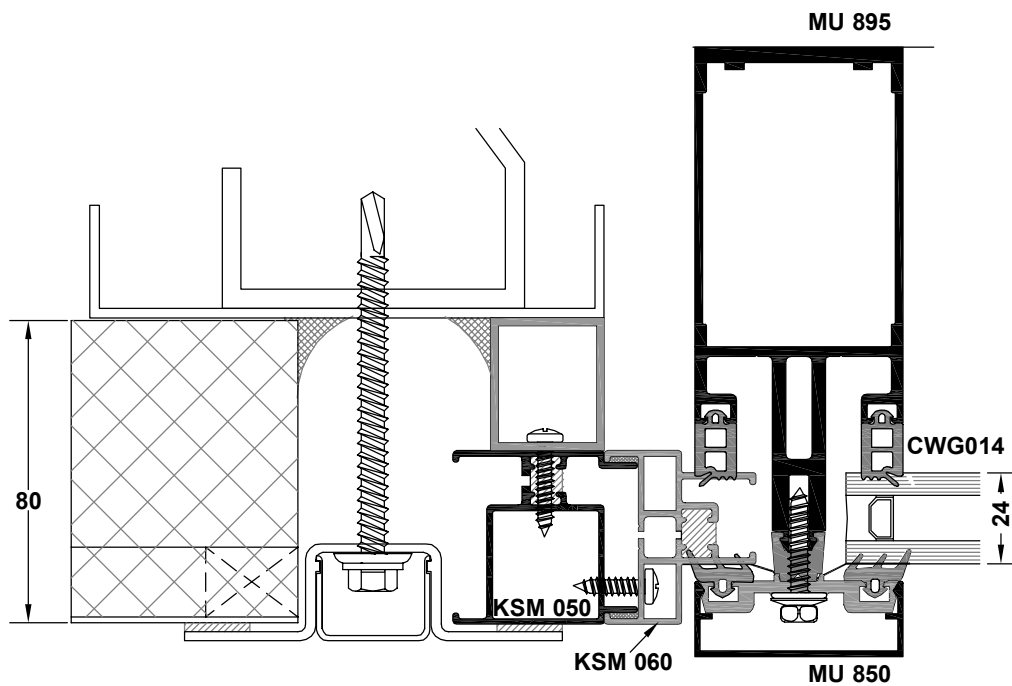
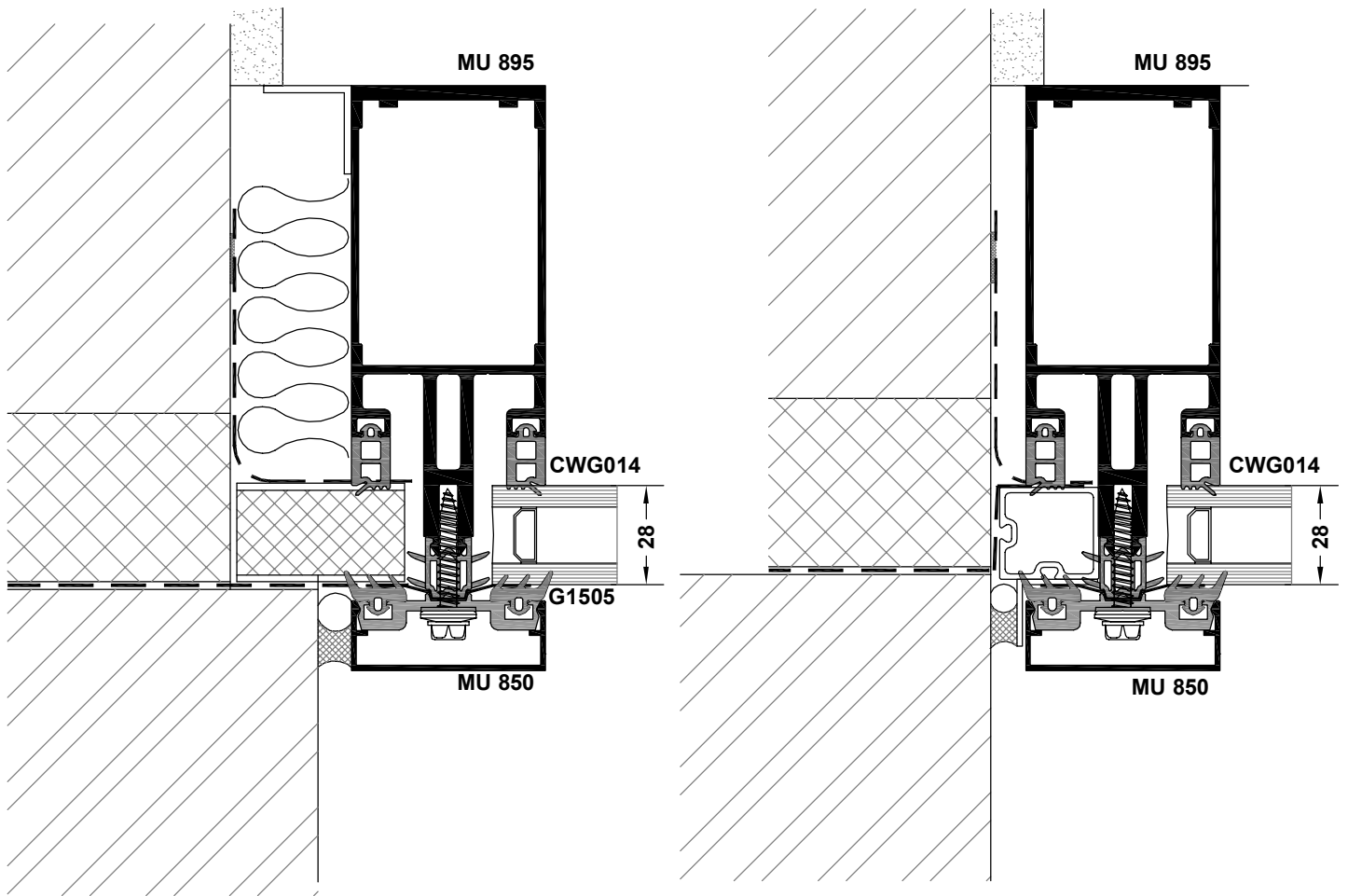

Section 1.1.21

Revision : B (---)

MU 800 SERIES MULLION DRAINED SYSTEM

Typical door jamb detail

Scale 1:2

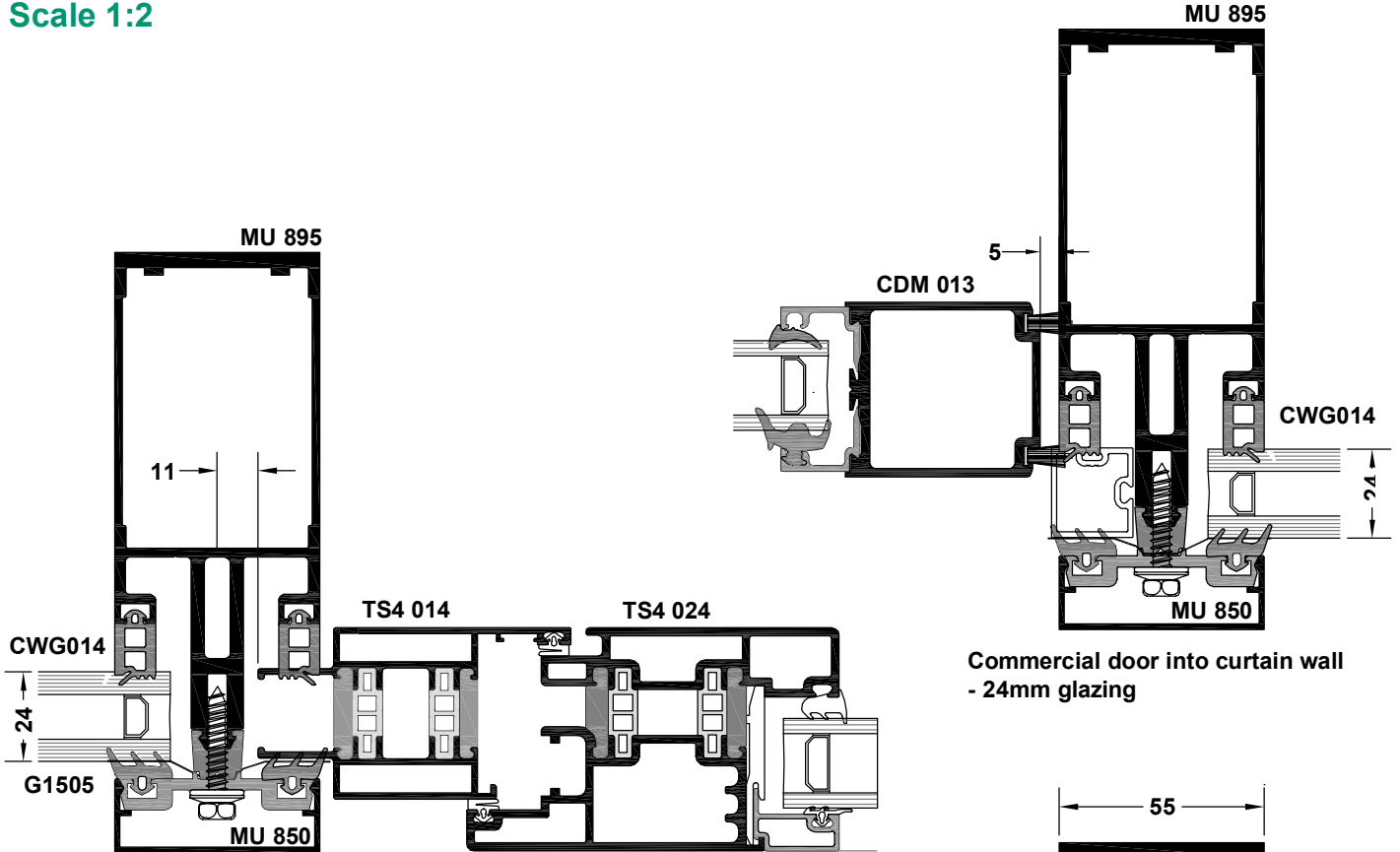

Rebated door into curtain wall - 24mm glazing

Commercial door into curtain wall - 24mm glazing

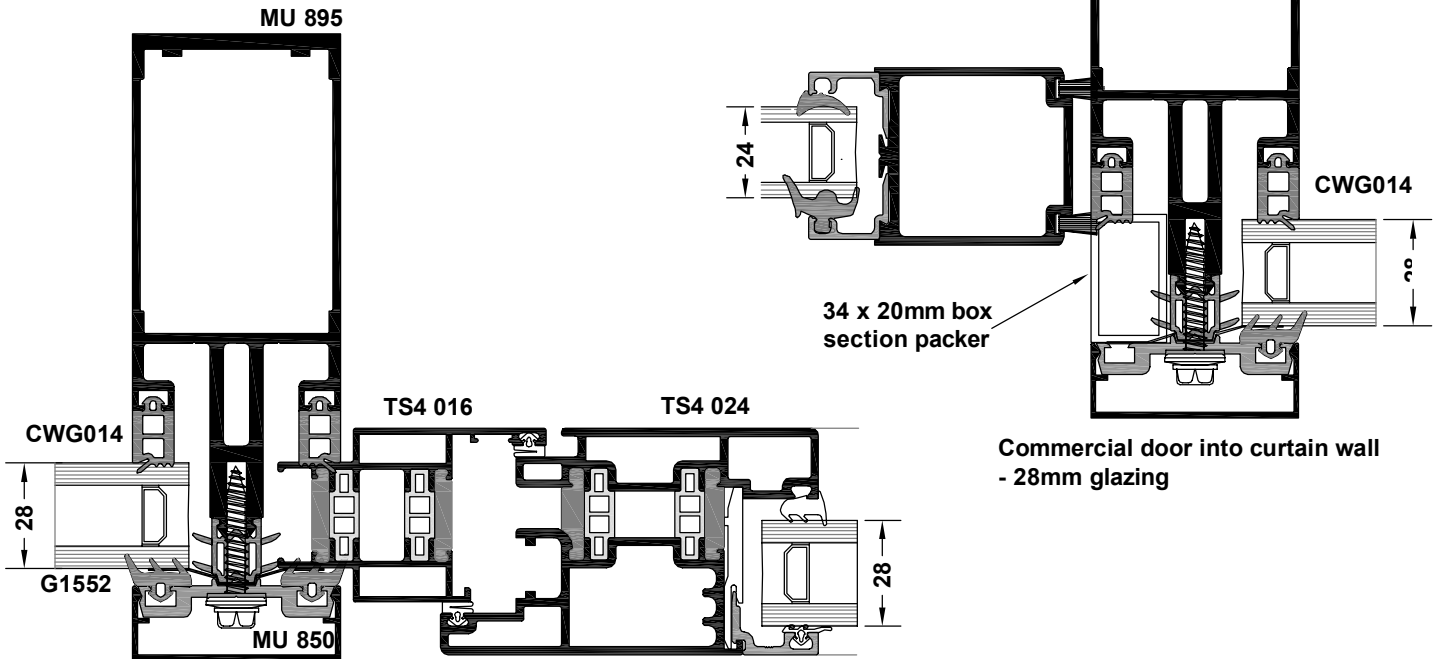

Rebated door into curtain wall - 28mm glazing

Commercial door into curtain wall - 28mm glazing

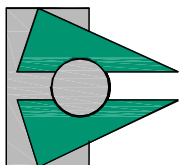

Section 1.1.22
Revision : B (---/---)

MU 800 SERIES MULLION DRAINED SYSTEM

Corner Assemblies

Scale NTS

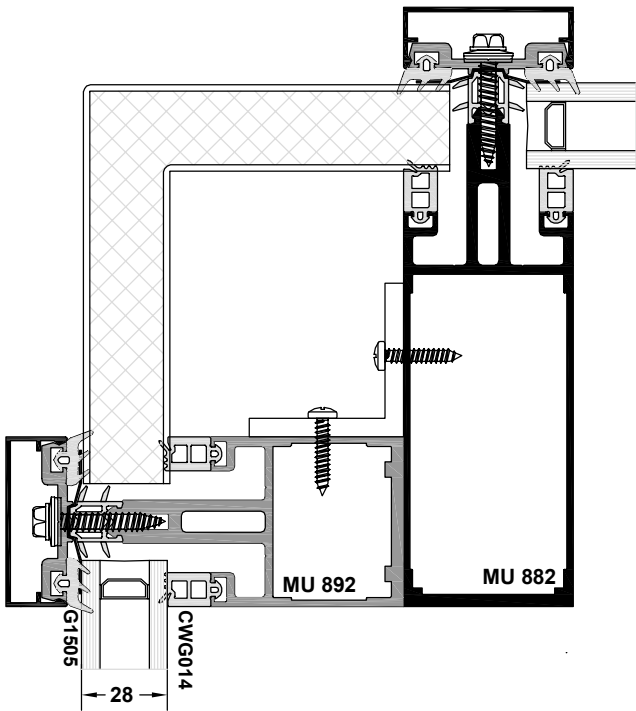

External corner with
MU 882 & MU 892

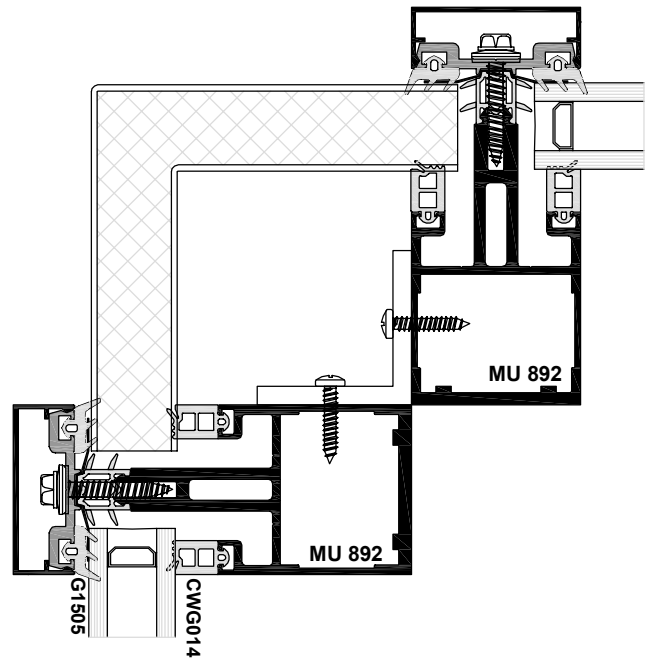

External corner with
MU 892

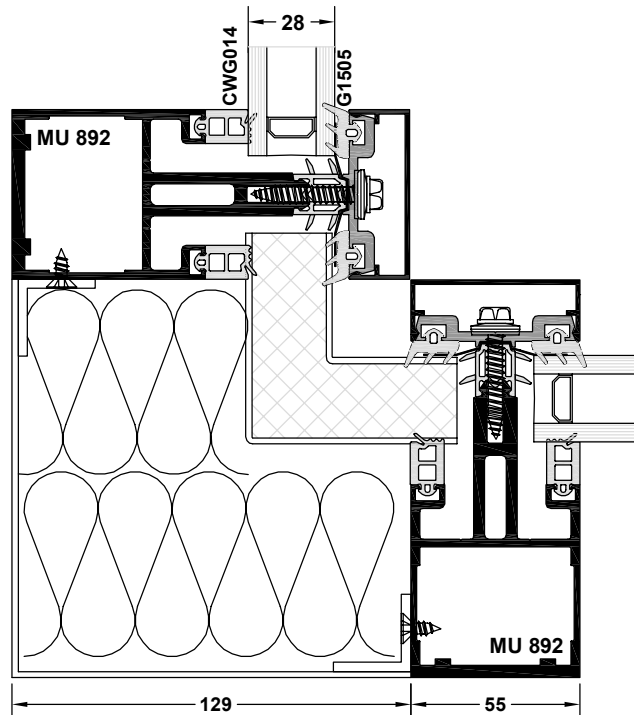

External corner with
MU 892

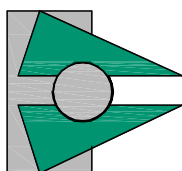

MU 800 SERIES MULLION DRAINED SYSTEM

Typical head detail - sloped glazing

Scale 1:2

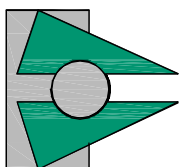
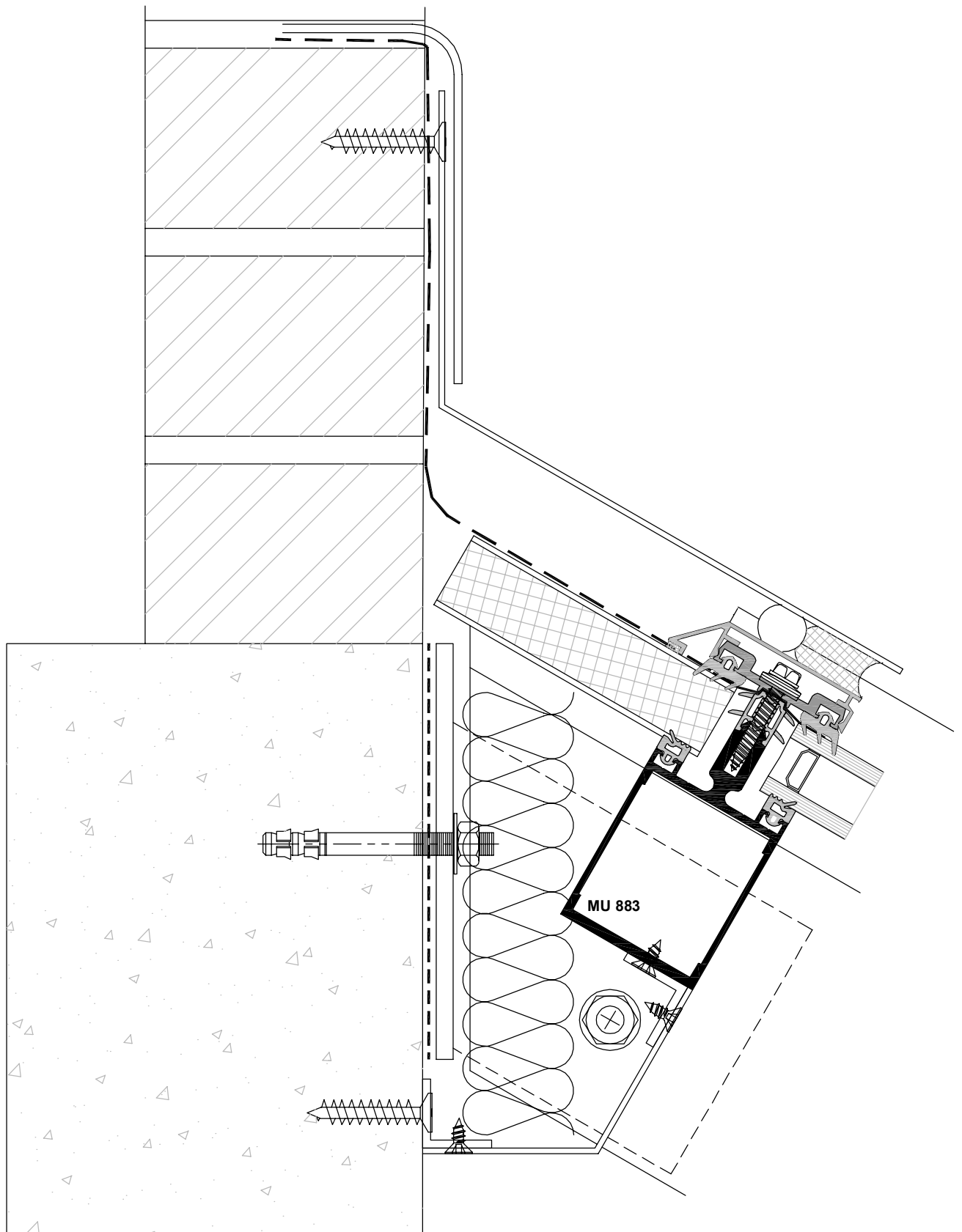

MU 800 SERIES MULLION DRAINED SYSTEM

Typical eaves detail

Scale 1:2

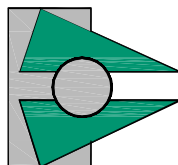
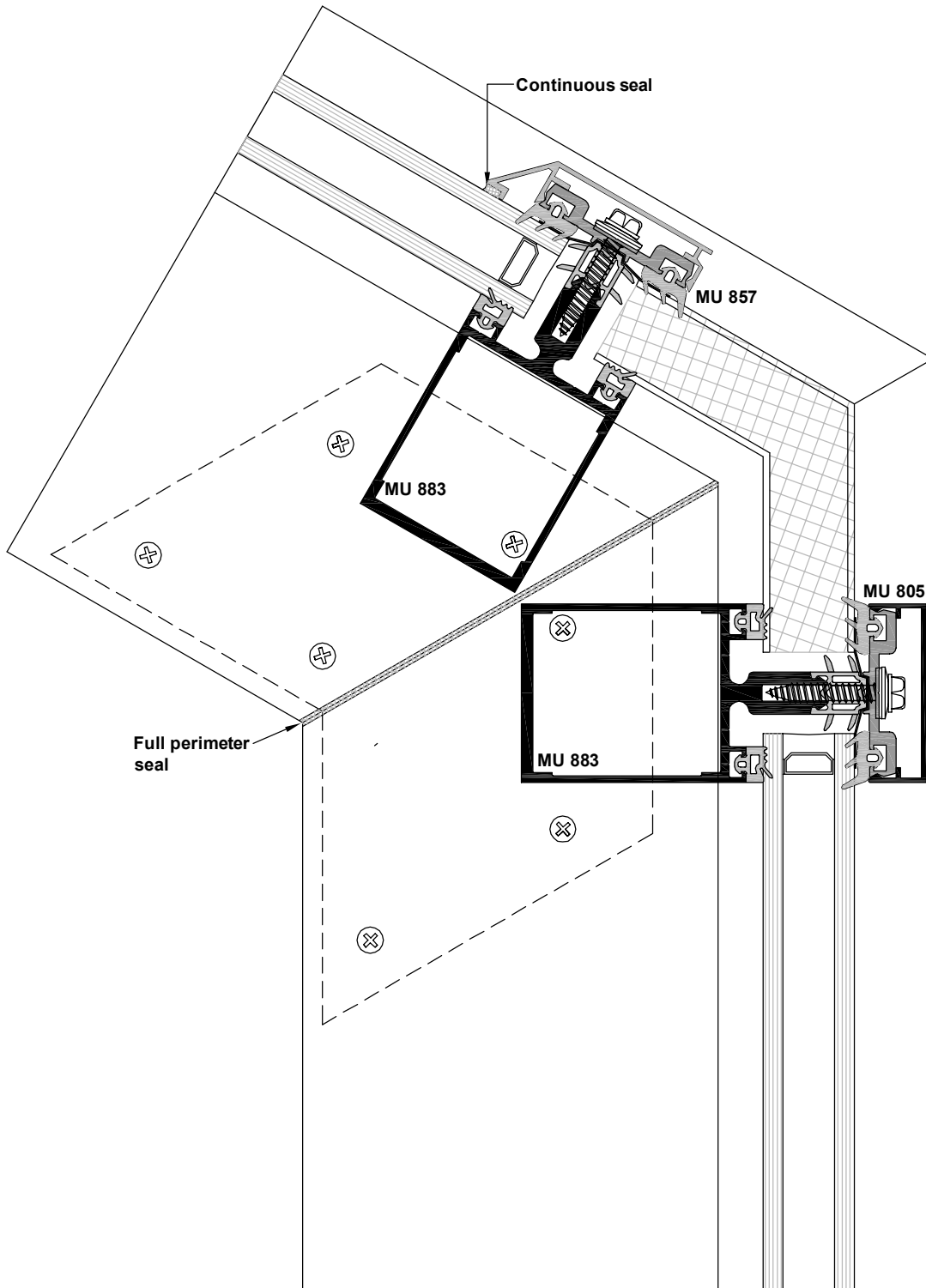

MU 800 SERIES MULLION DRAINED SYSTEM

Typical jamb detail - Sloped glazing

Scale 1:2

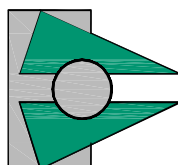
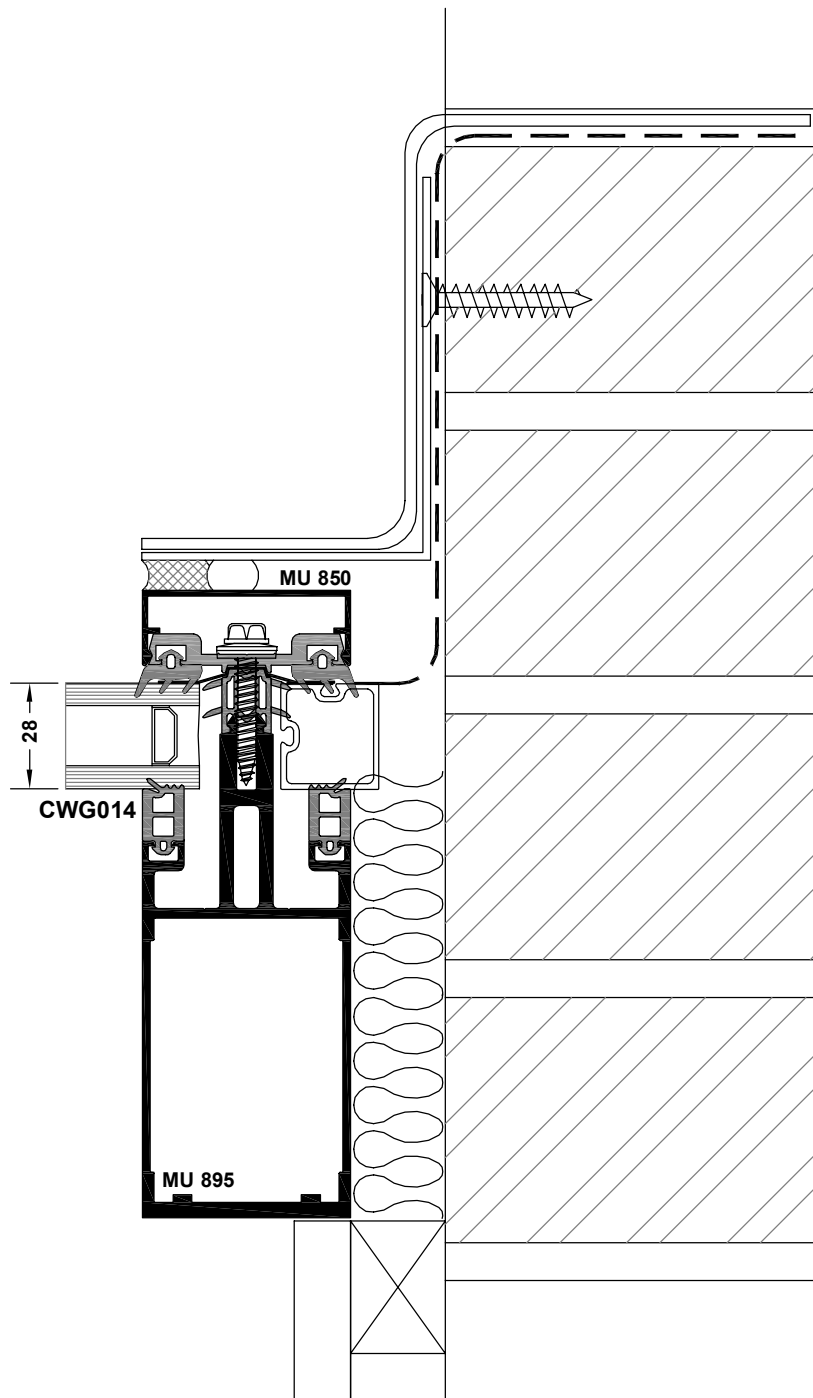

MU 800 SERIES MULLION DRAINED SYSTEM

False mullion detail

Scale 1:2

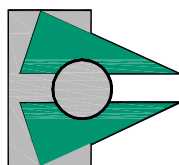
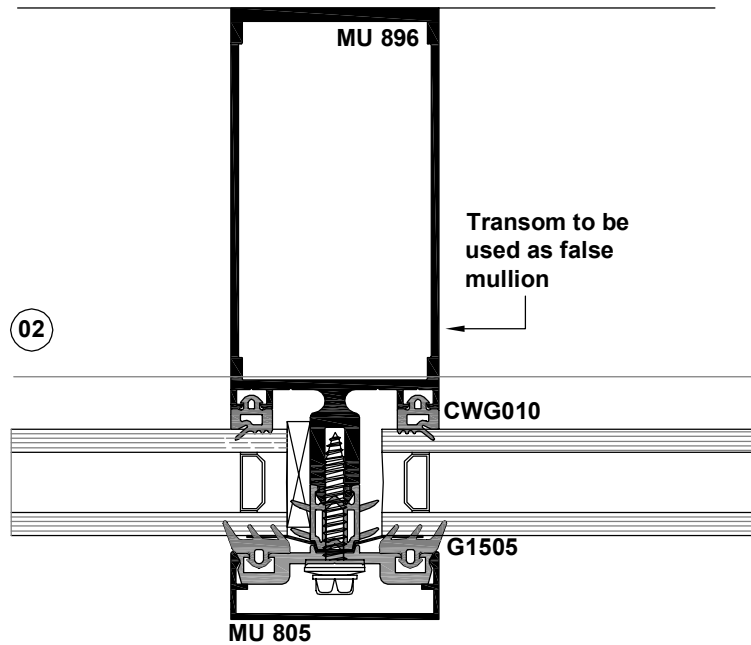
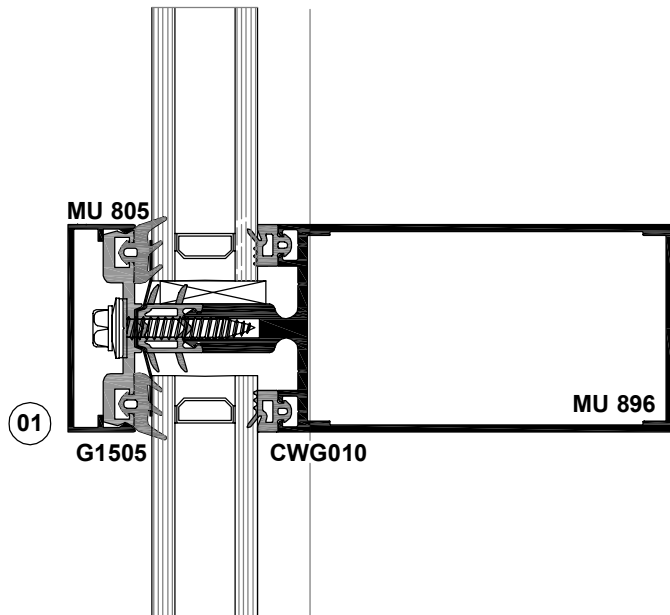
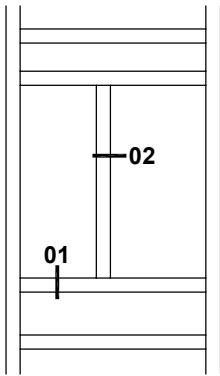

MU 800 SERIES MULLION DRAINED SYSTEM

Typical ridge detail

Scale NTS

Apply a perimeter seal around joint prior to fixing in position

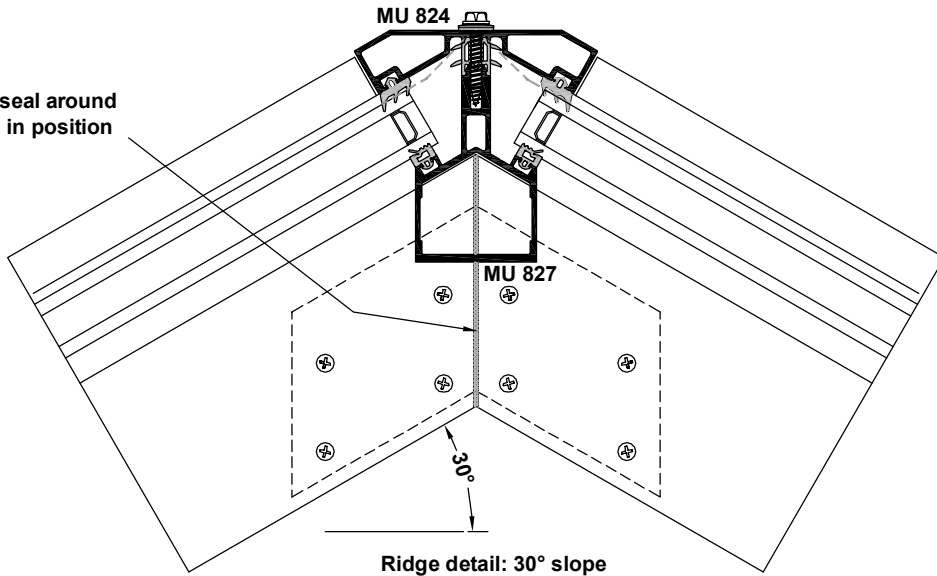

Ridge detail: 30° slope

Apply a perimeter seal around joint prior to fixing in position

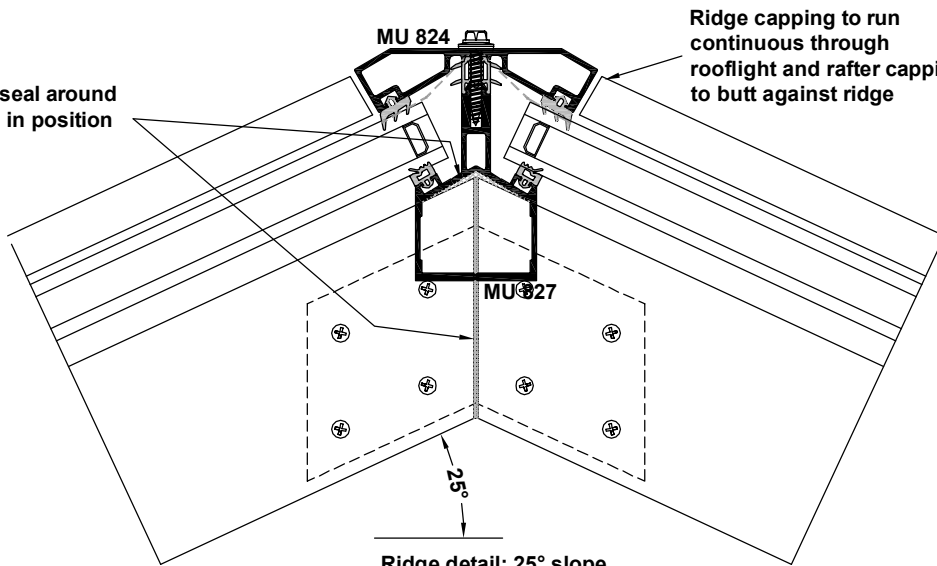

Ridge detail: 25° slope

Ridge capping to run continuous through rooflight and rafter capping to butt against ridge

Apply a perimeter seal around joint prior to fixing in position

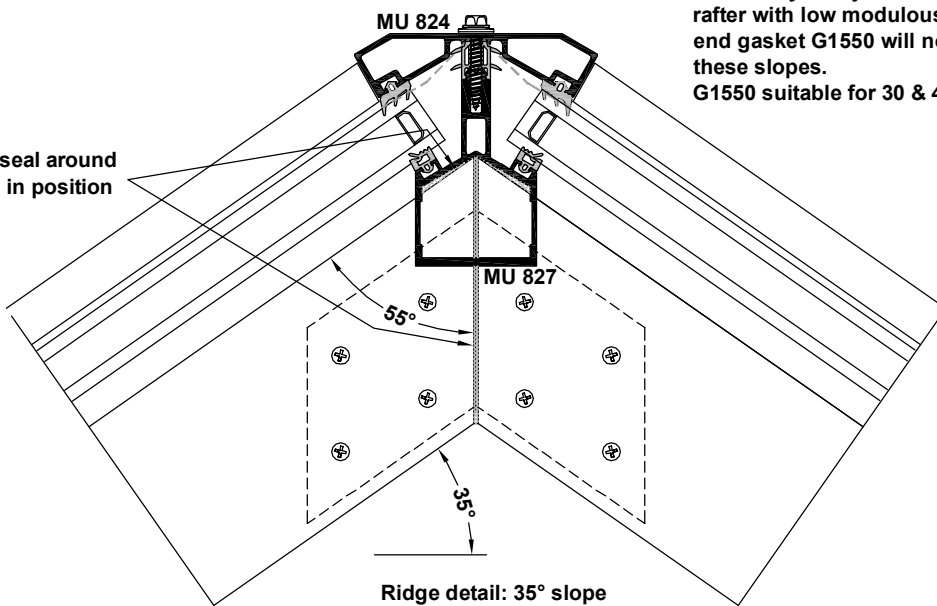

Ridge detail: 35° slope

For for roof slopes between 25 -29° and 31 to 35° fully seal joint between ridge bar and rafter with low modulus sealant. Transom end gasket G1550 will not be suitable for these slopes. G1550 suitable for 30 & 45° slopes only.

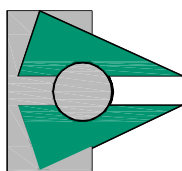

MU 800 SERIES MULLION DRAINED SYSTEM

Typical ridge detail

Scale NTS

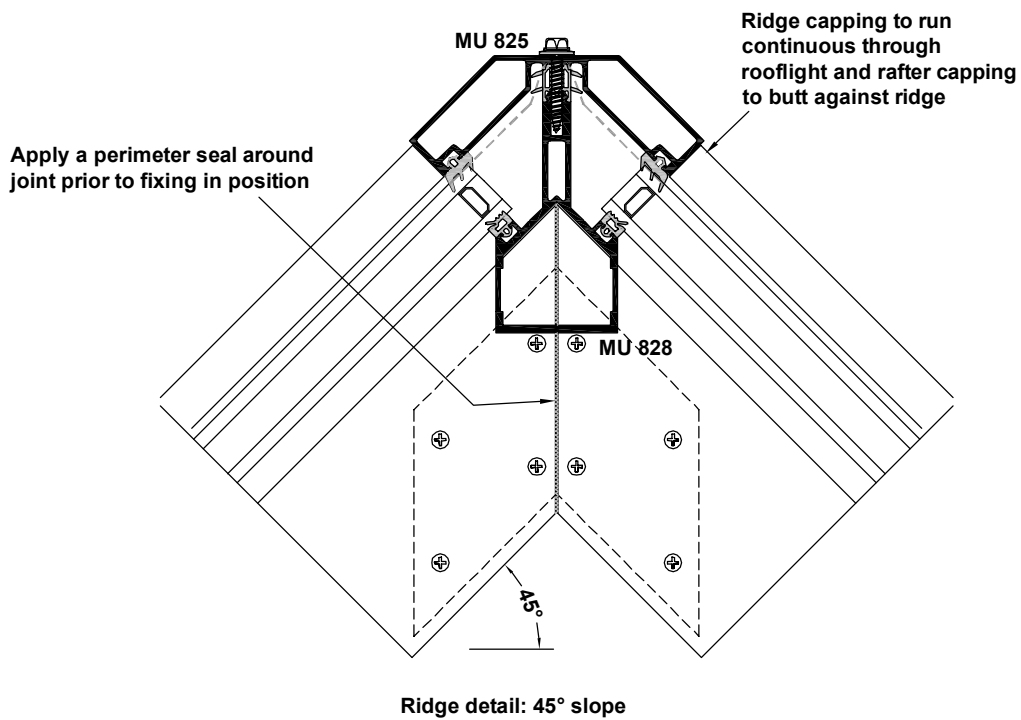

For for roof slopes between 40 -44° fully seal joint between ridge bar and rafter with low modulus sealant. Transom end gasket G1550 will not be suitable for these slopes. G1550 suitable for 30 & 45° slopes only

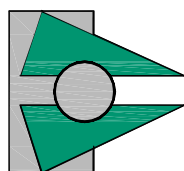
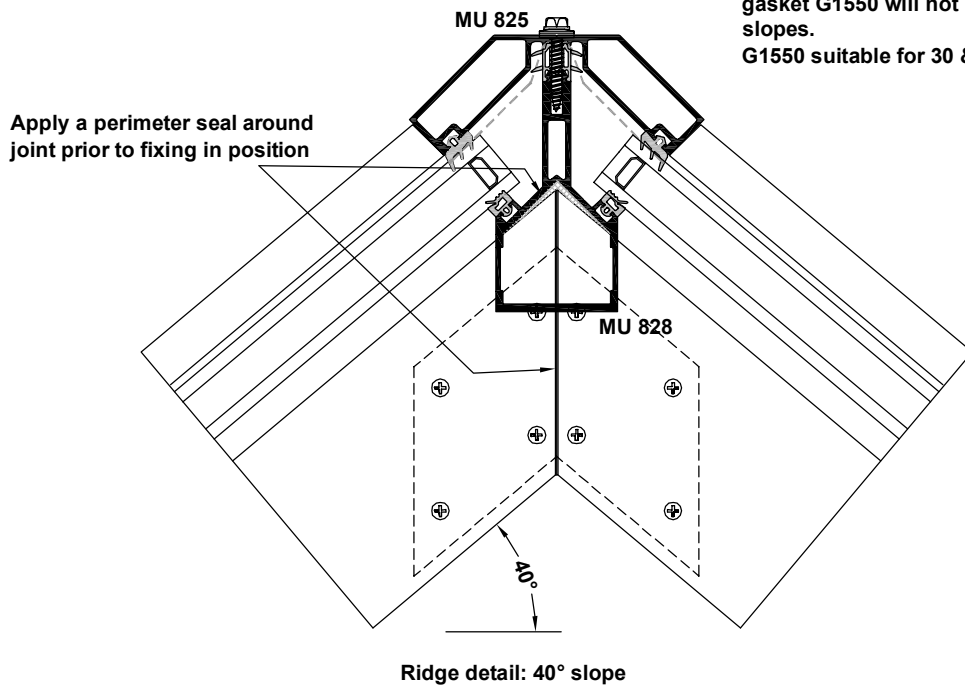

MU 800 SERIES MULLION DRAINED SYSTEM

Double transom ridge detail

Scale 1:2

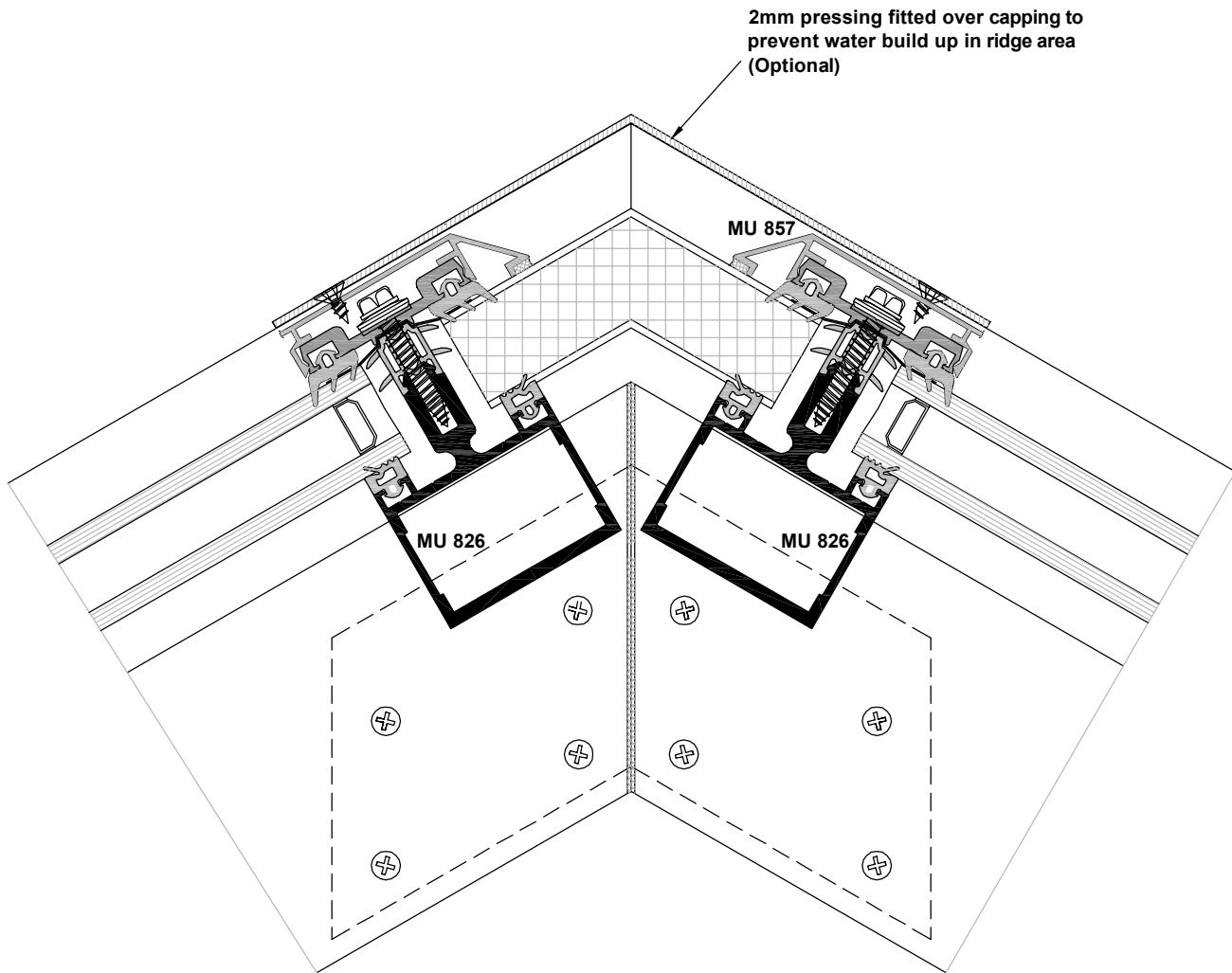

2mm pressing fitted over capping to prevent water build up in ridge area (Optional)

MU 857

MU 826

MU 826

Ridge detail:
Suitable for all roof slopes

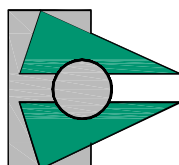

MU 800 SERIES MULLION DRAINED SYSTEM

Typical cill detail - Sloped glazing

Scale 1:2

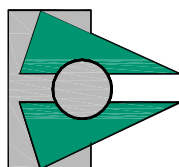
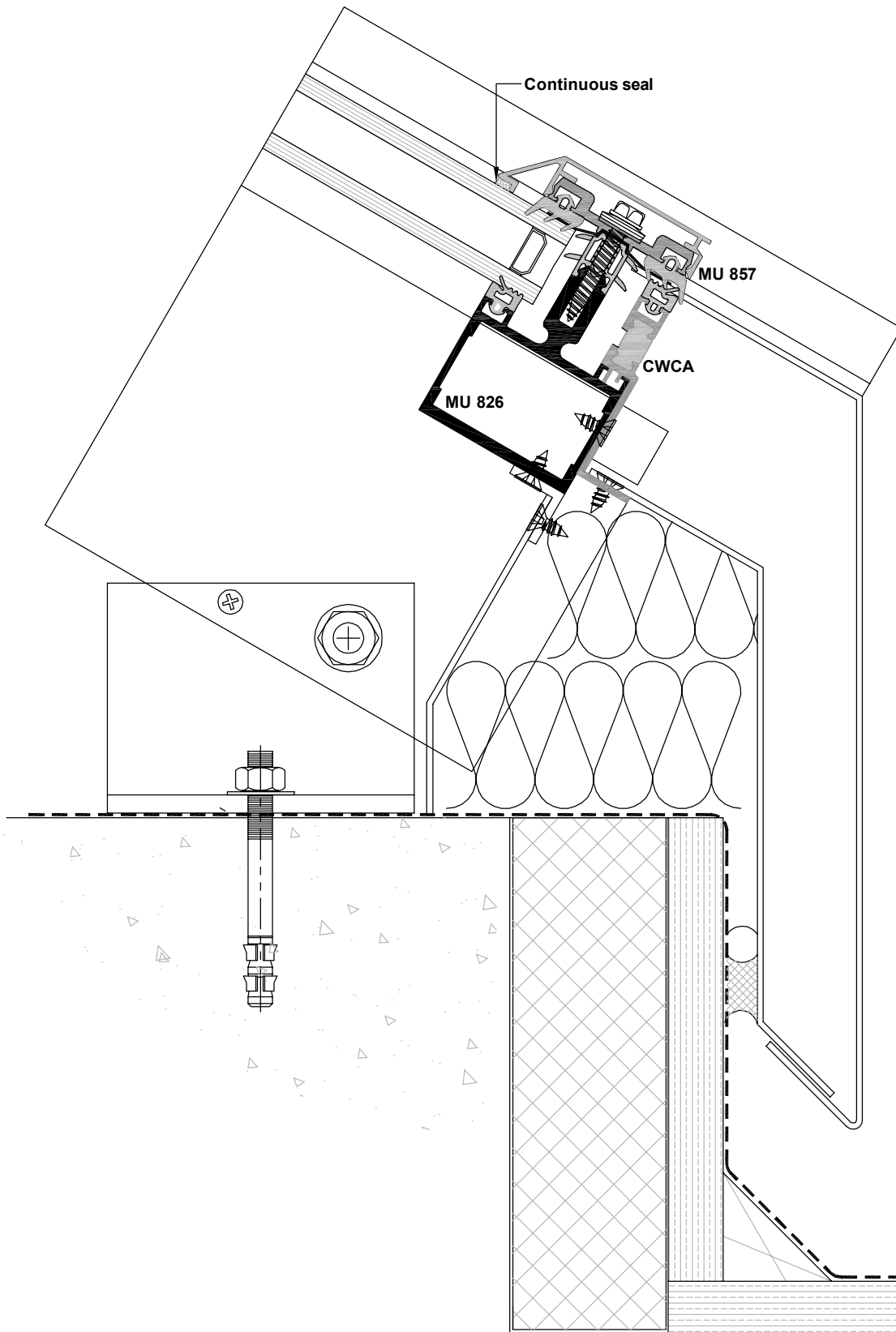

MU 800 SERIES MULLION DRAINED SYSTEM

Typical details - MU899-60

Scale NTS

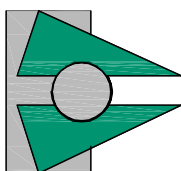
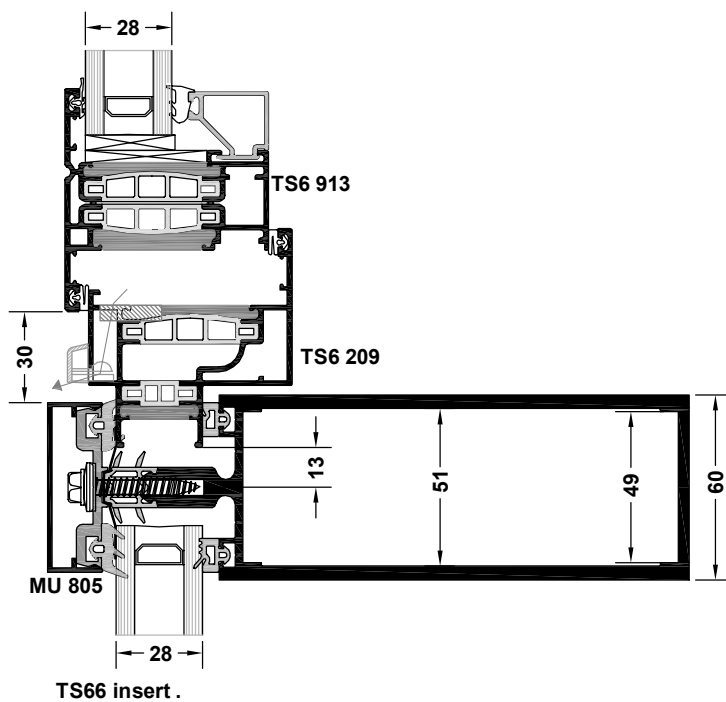
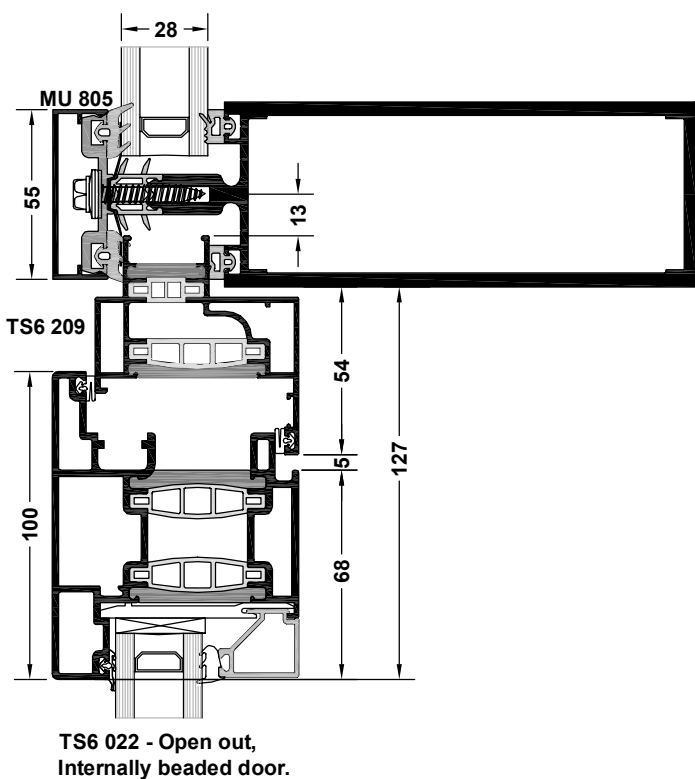
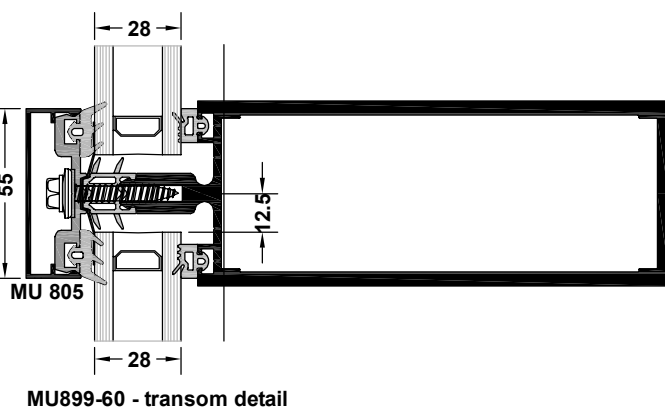
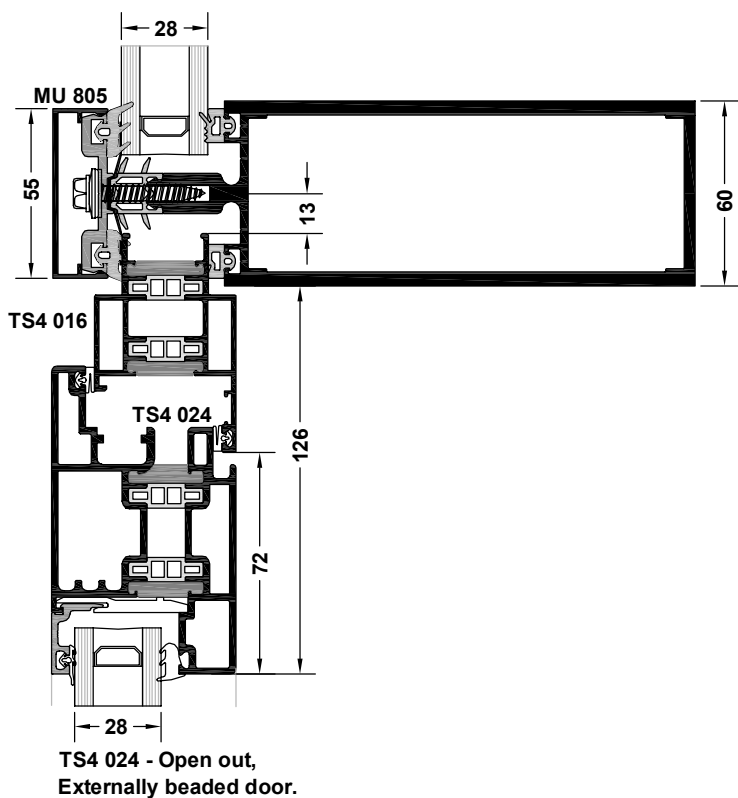

MU 800 SERIES MULLION DRAINED SYSTEM

Typical Inserts - 28mm glazing

Scale 1:2

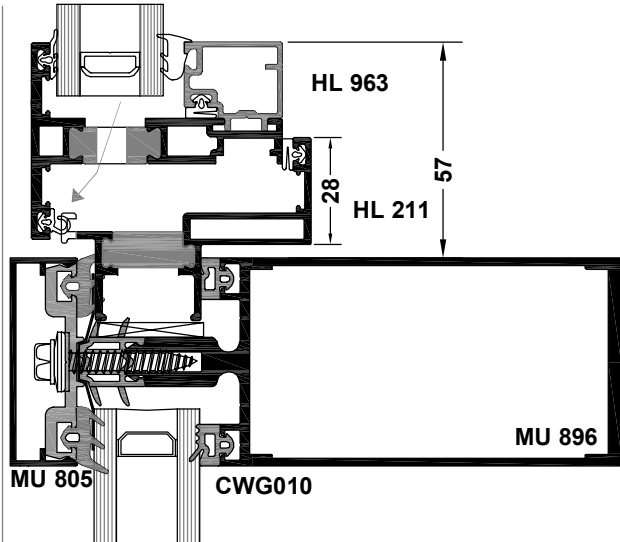

HL963 / HL 211
Slim line insert

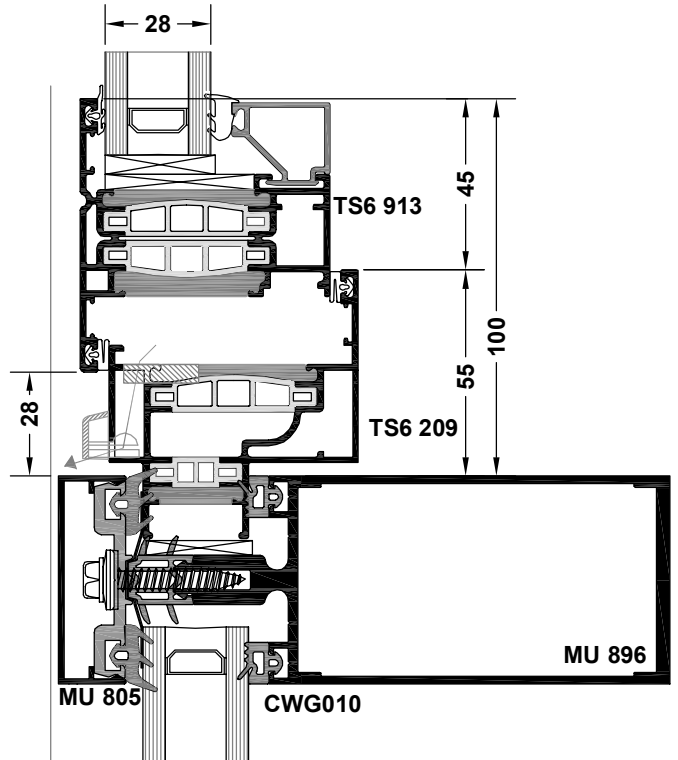

TS6 209 / TS6 913
Standard insert

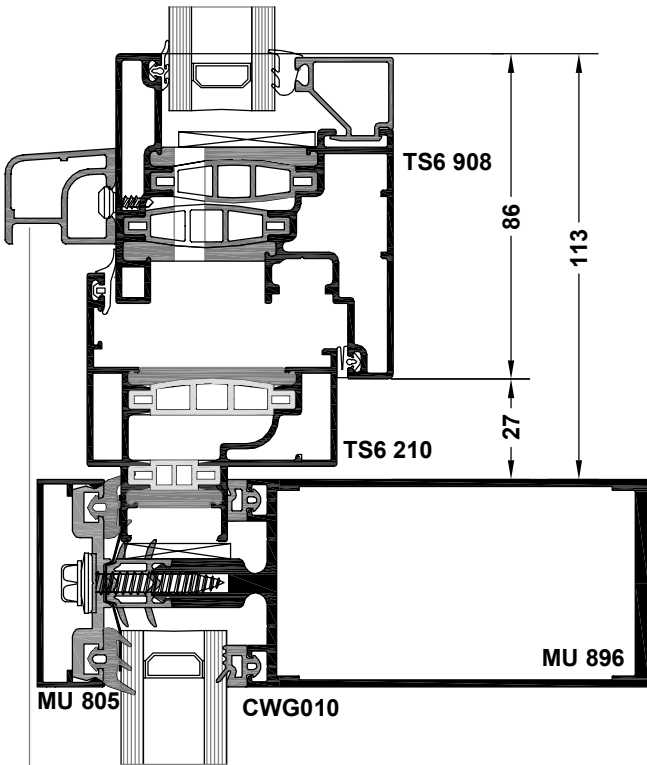

TS6 908
Tilt and turn insert

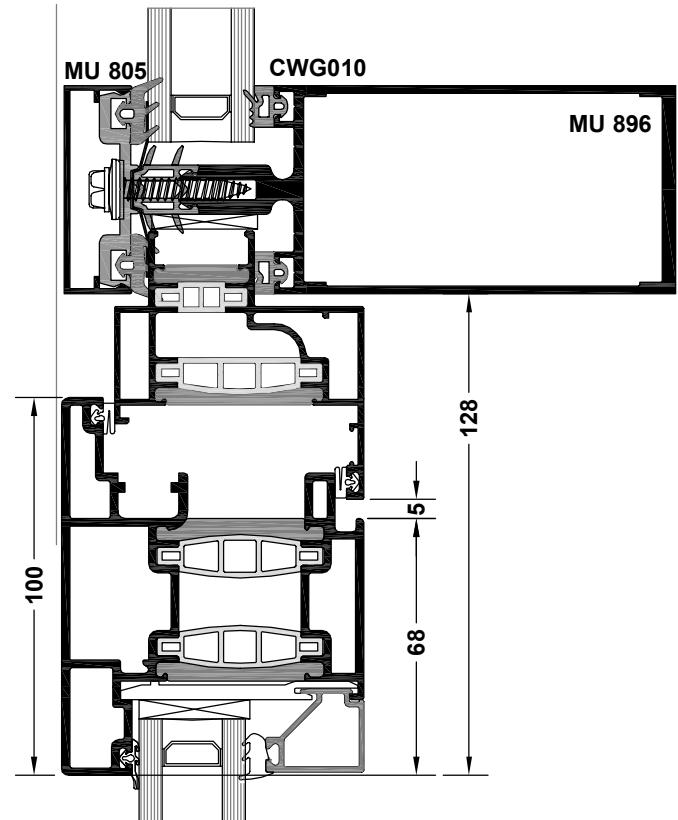

TS6 022 - Open out,
Internally beaded door.

